

Panasonic®

Operating Instructions Blu-ray Disc Home Theater Sound System

Model No. **SC-BT735**
SC-BT330
SC-BT230



The illustration shows the image of the unit SC-BT735.

Dear customer

Thank you for purchasing this product.

For optimum performance and safety, please read these instructions carefully.

Before connecting, operating or adjusting this product, please read the instructions completely.

Please keep this manual for future reference.



Model number suffix "EB" denotes UK model.



VQT2Q52

CAUTION!

THIS PRODUCT UTILIZES A LASER.
 USE OF CONTROLS OR ADJUSTMENTS OR
 PERFORMANCE OF PROCEDURES OTHER THAN
 THOSE SPECIFIED HEREIN MAY RESULT IN
 HAZARDOUS RADIATION EXPOSURE.
 DO NOT OPEN COVERS AND DO NOT REPAIR
 YOURSELF. REFER SERVICING TO QUALIFIED
 PERSONNEL.

CAUTION!

- DO NOT INSTALL OR PLACE THIS UNIT IN A BOOKCASE, BUILT-IN CABINET OR IN ANOTHER CONFINED SPACE. ENSURE THE UNIT IS WELL VENTILATED. TO PREVENT RISK OF ELECTRIC SHOCK OR FIRE HAZARD DUE TO OVERHEATING, ENSURE THAT CURTAINS AND ANY OTHER MATERIALS DO NOT OBSTRUCT THE VENTILATION VENTS.
- DO NOT OBSTRUCT THE UNIT'S VENTILATION OPENINGS WITH NEWSPAPERS, TABLECLOTHS, CURTAINS, AND SIMILAR ITEMS.
- DO NOT PLACE SOURCES OF NAKED FLAMES, SUCH AS LIGHTED CANDLES, ON THE UNIT.
- DISPOSE OF BATTERIES IN AN ENVIRONMENTALLY FRIENDLY MANNER.

WARNING:

TO REDUCE THE RISK OF FIRE, ELECTRIC SHOCK OR
 PRODUCT DAMAGE,

- DO NOT EXPOSE THIS APPARATUS TO RAIN, MOISTURE, DRIPPING OR SPLASHING AND THAT NO OBJECTS FILLED WITH LIQUIDS, SUCH AS VASES, SHALL BE PLACED ON THE APPARATUS.
- USE ONLY THE RECOMMENDED ACCESSORIES.
- DO NOT REMOVE THE COVER (OR BACK); THERE ARE NO USER SERVICEABLE PARTS INSIDE. REFER SERVICING TO QUALIFIED SERVICE PERSONNEL.

THIS UNIT IS INTENDED FOR USE IN MODERATE
 CLIMATES.

This product may receive radio interference caused by mobile telephones during use. If such interference is apparent, please increase separation between the product and the mobile telephone.

The socket outlet shall be installed near the equipment and easily accessible.
 The mains plug of the power supply cord shall remain readily operable.
 To completely disconnect this apparatus from the AC Mains, disconnect the power supply cord plug from AC receptacle.

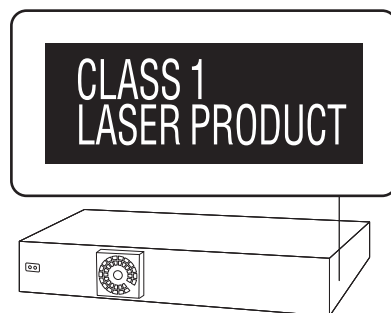

(Side of product)

CAUTION	VISIBLE AND INVISIBLE LASER RADIATION WHEN OPEN. DO NOT STARE INTO BEAM. FDA 21 CFR/Class II (Ira)
CAUTION	CLASS 1M VISIBLE AND INVISIBLE LASER RADIATION WHEN OPEN. DO NOT VIEW DIRECTLY WITH OPTICAL INSTRUMENTS. IEC60825-1, A2/CLASS 1M
ATTENTION	RAYONNEMENT LASER VISIBLE ET INVISIBLE. CLASSE 1M. EN CAS D'OUVERTURE. NE PAS REGARDER DIRECTEMENT À L'AIDE D'INSTRUMENTS OPTIQUES.
FORSIGTIG	SYNLIG OG USYNLIG LASERSTRÅLING KLASSE 1M. NÅR LÅGET ER ÅBENT, UNDGÅ AT SE LIGE PÅ MED OPTISKE INSTRUMENTER.
VARO	AVATTAESSA OLET ALLTIINA LUOKAN 1M NÄKYVÄÄ JA NÄKYMÄTÖNTÄ LASERSÄTELYÄ. ÄLÄ KATSO OPTISELLA LAITTEELLA SUORAAN SÄTEESEEN.
WARNING	KLASS 1M SYNLIG OCH OSYNLIG LASERSTRÅLING NÄR DENNA DEL ÄR ÖPPNAD, BETRÄKTA EJ STRÅLEN DIREKT GENOM OPTISKT INSTRUMENT.
VORSICHT	SICHTBARE UND UNSICHTBARE LASERSTRÄHLUNG KLASSE 1M. WENN ABDECKUNG GEÖFFNET, NICHT DIREKT MIT OPTISCHEN INSTRUMENTEN BETRACHTEN.
注意	— 打开时有可见及不可见激光辐射。避免光束照射。
注意	— ここを開くと可視及び不可視レーザー光が出ます。 — ビームを視たり、触れたりしないでください。 VOL1V70

(Inside of product)

Caution for AC Mains Lead



(For the United Kingdom and Republic of Ireland)

For your safety, please read the following text carefully.

This appliance is supplied with a moulded three pin mains plug for your safety and convenience.

A 5-ampere fuse is fitted in this plug.

Should the fuse need to be replaced please ensure that the replacement fuse has a rating of 5-ampere and that it is approved by ASTA or BSI to BS1362.

Check for the ASTA mark  or the BSI mark  on the body of the fuse.

If the plug contains a removable fuse cover you must ensure that it is refitted when the fuse is replaced.

If you lose the fuse cover the plug must not be used until a replacement cover is obtained.

A replacement fuse cover can be purchased from your local dealer.

Before use

Remove the connector cover.

How to replace the fuse

The location of the fuse differ according to the type of AC mains plug (figures A and B). Confirm the AC mains plug fitted and follow the instructions below.

Illustrations may differ from actual AC mains plug.

- 1 Open the fuse cover with a screwdriver.

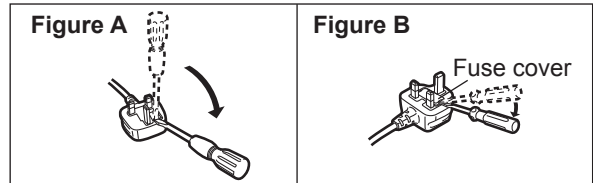

- 2 Replace the fuse and close or attach the fuse cover.

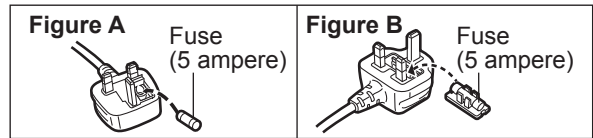

CAUTION!

IF THE FITTED MOULDED PLUG IS UNSUITABLE FOR THE SOCKET OUTLET IN YOUR HOME THEN THE FUSE SHOULD BE REMOVED AND THE PLUG CUT OFF AND DISPOSED OF SAFELY.

THERE IS A DANGER OF SEVERE ELECTRICAL SHOCK IF THE CUT OFF PLUG IS INSERTED INTO ANY 13-AMPERE SOCKET.

If a new plug is to be fitted please observe the wiring code as stated below.

If in any doubt please consult a qualified electrician.

IMPORTANT

The wires in this mains lead are coloured in accordance with the following code:

Blue: Neutral, Brown: Live.

As these colours may not correspond with the coloured markings identifying the terminals in your plug, proceed as follows:

The wire which is coloured Blue must be connected to the terminal which is marked with the letter N or coloured Black or Blue.

The wire which is coloured Brown must be connected to the terminal which is marked with the letter L or coloured Brown or Red.

WARNING: DO NOT CONNECT EITHER WIRE TO THE EARTH TERMINAL WHICH IS MARKED WITH THE LETTER E, BY THE EARTH SYMBOL  OR COLOURED GREEN OR GREEN/YELLOW.

THIS PLUG IS NOT WATERPROOF—KEEP DRY.

Safety precautions

Placement

Set the unit up on an even surface away from direct sunlight, high temperatures, high humidity, and excessive vibration. These conditions can damage the cabinet and other components, thereby shortening the unit's service life. Do not place heavy items on the unit.

Voltage

Do not use high voltage power sources. This can overload the unit and cause a fire. Do not use a DC power source. Check the source carefully when setting the unit up on a ship or other place where DC is used.

AC mains lead protection

Ensure the AC mains lead is connected correctly and not damaged. Poor connection and lead damage can cause fire or electric shock. Do not pull, bend, or place heavy items on the lead.

Grasp the plug firmly when unplugging the lead. Pulling the AC mains lead can cause electric shock. Do not handle the plug with wet hands. This can cause electric shock.

Foreign matter

Do not let metal objects fall inside the unit. This can cause electric shock or malfunction.

Do not let liquids get into the unit. This can cause electric shock or malfunction. If this occurs, immediately disconnect the unit from the power supply and contact your dealer.

Do not spray insecticides onto or into the unit. They contain flammable gases which can ignite if sprayed into the unit.

Service

Do not attempt to repair this unit by yourself. If sound is interrupted, indicators fail to light, smoke appears, or any other problem that is not covered in these instructions occurs, disconnect the AC mains lead and contact your dealer or an authorized service centre. Electric shock or damage to the unit can occur if the unit is repaired, disassembled or reconstructed by unqualified persons.

Extend operating life by disconnecting the unit from the power source if it is not to be used for a long time.

Information for Users on Collection and Disposal of Old Equipment and used Batteries



These symbols on the products, packaging, and/or accompanying documents mean that used electrical and electronic products and batteries should not be mixed with general household waste.



For proper treatment, recovery and recycling of old products and used batteries, please take them to applicable collection points, in accordance with your national legislation and the Directives 2002/96/EC and 2006/66/EC.

By disposing of these products and batteries correctly, you will help to save valuable resources and prevent any potential negative effects on human health and the environment which could otherwise arise from inappropriate waste handling.

For more information about collection and recycling of old products and batteries, please contact your local municipality, your waste disposal service or the point of sale where you purchased the items.

Penalties may be applicable for incorrect disposal of this waste, in accordance with national legislation.



For business users in the European Union

If you wish to discard electrical and electronic equipment, please contact your dealer or supplier for further information.

[Information on Disposal in other Countries outside the European Union]

These symbols are only valid in the European Union. If you wish to discard these items, please contact your local authorities or dealer and ask for the correct method of disposal.



Cd

Note for the battery symbol (bottom two symbol examples):

This symbol might be used in combination with a chemical symbol. In this case it complies with the requirement set by the Directive for the chemical involved.

Table of contents

Caution for AC Mains Lead	3
Safety precautions	4

Getting started

Accessory	6
Unit and media care	7
Using the remote control	7
Control reference guide	8
•Remote control	8
•Main unit (Front)	9
•Main unit (Rear)	9
Playable discs/Cards/USB devices	10
STEP 1: Preparing the speakers	12
•Assembling the speakers	12
•Speaker assembly option	13
STEP 2: Positioning	14
STEP 3: Connections	15
•Speaker cable connection	15
•Radio antenna connection	15
•Connection to a TV	16
•Connection to a broadband network	18
STEP 4 : AC mains lead connection	18
STEP 5: Smart setup / Easy setup	19
•Network Easy Setting	20
•Firmware updating	21
STEP 6:	
Reprogramming the remote control	22
Inserting or removing a media	22
START menu	23
Enjoying sound effects from all speakers	24
•Enjoying surround sound effects	24

Playback

Playing video contents	25
•Other operations during play	25
•Useful functions	26
•Enjoying BD-Live or BONUSVIEW in BD-Video	26
•Regarding DivX	27
Playing music	27
Playing still pictures	28
•Useful functions	28

Radio

Listening to the Radio	29
•Presetting stations automatically	29
•Presetting stations manually	29
•Listening/confirming the preset channels	29
•RDS broadcasting	29

TV

Enjoying TV with unit's speakers	30
•Surround sound effects	30
•Sound modes	30
•Making settings for digital audio input	30
Linked operations with the TV (VIERA Link "HDAVI Control™")	31
•Setting the audio link	31
•Easy control only with VIERA remote control	32

Other devices

Using the iPod/iPhone	32
•iPod/iPhone Connection	32
•iPod/iPhone Playback	33

Advanced operations

Enjoying VIERA CAST	34
Playback menu	34
DLNA feature	36
Setup menu	37
•Speaker settings	41

Optional speaker settings

Speaker installation option	42
-----------------------------------	----

Reference

Troubleshooting guide	43
Messages	45
About MP3/JPEG/DivX/ AVCHD/MPEG2 files	46
Supplemental information	47
Glossary	49
Specifications	50
Index	Back Cover

- These operating instructions are applicable to models SC-BT735, SC-BT330 and SC-BT230. Unless otherwise indicated, illustrations in these operating instructions are of SC-BT735.
- Operations in these instructions are described mainly with the remote control, but you can perform the operations on the main unit if the controls are the same.

Indicates features applicable to:

BT735: SC-BT735 only

BT330: SC-BT330 only

BT230: SC-BT230 only

System		SC-BT735	SC-BT330	SC-BT230
Main unit		SA-BT735	SA-BT330	SA-BT230
Speaker system	Front speakers	SB-HF730	SB-HF330	SB-HF230
	Centre speaker	SB-HC730	SB-HC230	SB-HC230
	Surround speakers	SB-HS735	SB-HS230	SB-HS230
Subwoofer		SB-HW330	SB-HW330	SB-HW480

- Some models may not be on sale in certain regions.
- Some accessories and external devices mentioned in these operating instructions that are not included with this product may not be on sale in certain regions.

Accessory

Check the supplied accessories before using this unit.

<p>BT735 BT330 BT230</p> <p><input type="checkbox"/> 1 Remote control (N2QAKB000090)</p> <p><input type="checkbox"/> 2 Batteries for remote control</p> <p><input type="checkbox"/> 1 Video cable (K2KA2BA00001)</p> <p><input type="checkbox"/> 1 FM indoor antenna (RSAX0002)</p> <p><input type="checkbox"/> 1 Antenna plug adaptor (K1YZ02000013)</p> <p><input type="checkbox"/> 1 Sheet of speaker cable stickers</p> <p><input type="checkbox"/> 1 AC mains lead (RFAX1022)</p> <p><input type="checkbox"/> 1 Speaker cable (centre) [REEX1154] with green connector</p> <p><input type="checkbox"/> 1 AC mains lead (RFAX0024)</p> <p><input type="checkbox"/> 1 Antenna plug adaptor (K1YZ02000013) For the United Kingdom and Republic of Ireland</p>				
<p>BT230</p> <p><input type="checkbox"/> Speaker cables (front) [REEX1152A] with red connector [REEX1153A] with white connector (surround) [REEX1155] with grey connector [REEX1156] with blue connector</p>				
<p>BT735</p> <p><input type="checkbox"/> 1 Auto speaker setup microphone (LOCBAY000051)</p> <p><input type="checkbox"/> 4 Speaker stands (with cable) [RYK1609-K] with white connector [RYK1609A-K] with red connector [RYK1609C-K] with grey connector [RYK1609B-K] with blue connector</p> <p><input type="checkbox"/> 4 Bases (RYK1610-K)</p> <p><input type="checkbox"/> 8 Screws (XTN5+10FFJK)</p> <p><input type="checkbox"/> 4 Screws (XYN5+J16FJK)</p>				
<p>BT330</p> <p><input type="checkbox"/> 1 Auto speaker setup microphone (LOCBAY000051)</p> <p><input type="checkbox"/> 2 Speaker stands (with cable) [RYPX1041-KL] with white connector [RYPX1041-KR] with red connector</p> <p><input type="checkbox"/> Speaker cables (surround) [REEX1155] with grey connector [REEX1156] with blue connector</p> <p><input type="checkbox"/> 2 Bases (RYPX0389-K)</p> <p><input type="checkbox"/> 8 Screws (XTN5+10FFJK)</p>				



- Product numbers correct as of December 2009. These may be subject to change.
- Do not use AC mains lead with other equipment.

■ Sales and Support Information

Customer Care Centre

- For customers within the UK: 0844 844 3852
- For customers within the Republic of Ireland: 01 289 8333
- Visit our website for product information
www.panasonic.co.uk
- E-mail: customer.care@panasonic.co.uk

Direct Sales at Panasonic UK

- For customers: 0844 844 3856
- Order accessory and consumable items for your product with ease and confidence by phoning our Customer Care Centre
Monday–Thursday 9:00 a.m.–5:30 p.m., Friday 9:30 a.m.–5:30 p.m.
(Excluding public holidays)

- Or go on line through our Internet Accessory ordering application at www.pas-europe.com
- Most major credit and debit cards accepted.
- All enquiries transactions and distribution facilities are provided directly by Panasonic UK Ltd.
- It couldn't be simpler!
- Also available through our Internet is direct shopping for a wide range of finished products, take a browse on our website for further details.

Unit and media care

■ Clean this unit with a soft, dry cloth

- Never use alcohol, paint thinner or benzene to clean this unit.
- Before using chemically treated cloth, carefully read the instructions that came with the cloth.

■ Clean the lens with the lens cleaner

Lens cleaner: RP-CL720E

- This lens cleaner may not be available for sale in all countries, e.g. not available in Germany, please consult your Panasonic dealer for advice.
- This lens cleaner is primarily for use on Panasonic DVD recorders (DIGA), but it is also suitable for use on this unit.

■ Clean discs

DO



DO NOT



Wipe with a damp cloth and then wipe dry.

■ Disc and card handling precautions

- Handle discs by the edges to avoid inadvertent scratches or fingerprints on the disc.
- Do not attach labels or stickers to discs.
- Do not use record cleaning sprays, benzene, thinner, static electricity prevention liquids or any other solvent.
- Clean any dust, water, or foreign matter from the terminals on the rear side of the card.
- Do not use the following discs:
 - Discs with exposed adhesive from removed stickers or labels (rented discs etc).
 - Discs that are badly warped or cracked.
 - Irregularly shaped discs, such as heart shapes.

■ To dispose or transfer this unit

The unit may keep the user settings information in the unit. If you discard this unit either by disposal or transfer, then follow the procedure to return all the settings to the factory presets to delete the user settings. (⇒ 43, "To return to the factory preset.")

- The operation history may be recorded in the memory of this unit.

Using the remote control

Insert so the poles (+ and –) match those in the remote control.

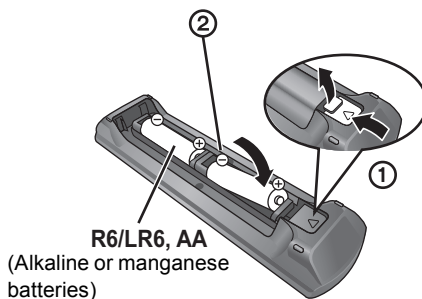

Point it at remote control signal sensor on this unit. (⇒ 9)



Mishandling of batteries can cause electrolyte leakage which can damage items the fluid contacts and may cause a fire.

- Do not mix old and new batteries or different types at the same time.
 - Do not heat or expose to flame.
 - Do not leave the battery(ies) in an automobile exposed to direct sunlight for a long period of time with doors and windows closed.
 - Do not take apart or short circuit.
 - Do not attempt to recharge alkaline or manganese batteries.
 - Do not use batteries if the covering has been peeled off.
- Remove batteries if the remote control is not going to be used for a long period of time. Store in a cool, dark place.

CAUTION

Danger of explosion if battery is incorrectly replaced. Replace only with the same or equivalent type recommended by the manufacturer. Dispose of used batteries according to the manufacturer's instructions.

Control reference guide

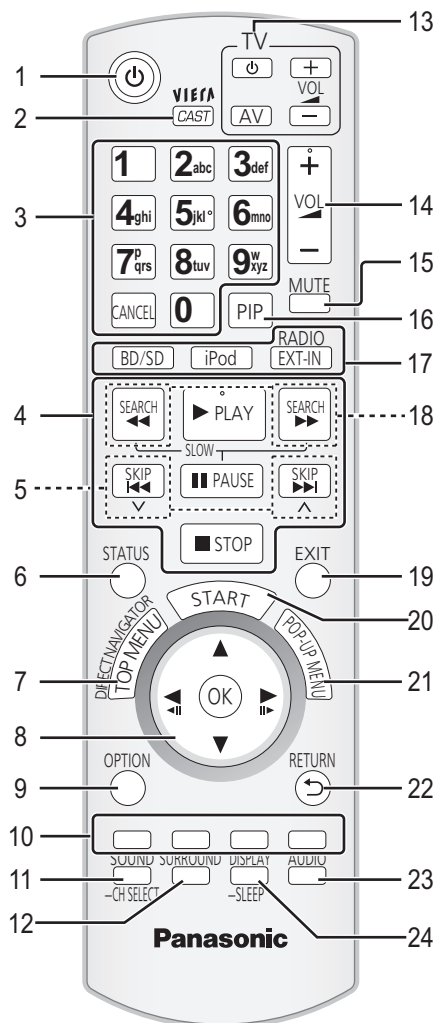

Remote control

- 1 Turn the unit on and off (⇒ 19)
- 2 Display the Home screen of VIERA CAST (⇒ 34)
- 3 Select title numbers, etc./Enter numbers or characters (⇒ 34)
[CANCEL]: Cancel
- 4 Basic playback control buttons (⇒ 25)
- 5 Select preset radio stations (⇒ 29)
- 6 Show status messages (⇒ 25)
- 7 Show Top Menu/DIRECT NAVIGATOR (⇒ 25)
- 8 [▲, ▼, ◀, ▶]: Menu selection
[OK]: Selection
[◀, ▶]: Select preset radio station (⇒ 29)
[◀] (◀||), [▶] (||▶): Frame-by-frame (⇒ 25)
- 9 Show OPTION menu (⇒ 26)
- 10 Coloured buttons (red, green, yellow, blue)
These buttons are used when;
 - Operating a BD-Video disc that includes Java™ applications (BD-J).
 - Displaying "Title View" and "Album View" screens. (⇒ 28)
 - Operating contents of VIERA CAST (⇒ 34)
- 11 Set the sound mode (⇒ 24)/Select speaker channel (⇒ 24)
- 12 Select surround sound effects (⇒ 24)
- 13 **TV operation buttons**
You can operate the TV through the unit's remote control.
[TV]: Turn the television on and off
[AV]: Switch the input select
[+ - VOL]: Adjust the volume
- 14 Adjust the volume of the main unit
- 15 Mute the sound
 - "MUTE" flashes on the unit's display, while the function is on.
 - To cancel, press the button again or adjust the volume.
 - Muting is cancelled if the unit is turned off.
- 16 Switch on/off Secondary Video (Picture-in-picture) (⇒ 26)
- 17 Select the source
[BD/SD]: Select disc drive or SD card drive (⇒ 23)
[iPod]: Select iPod/iPhone as the source (⇒ 23, 33)
[RADIO/EXT-IN]: Select FM tuner, USB or external audio as the source (⇒ 23, 29, 30)
- 18 Select radio stations manually (⇒ 29)
- 19 Exit the menu screen
- 20 Show START menu (⇒ 23)
- 21 Show Pop-up menu (⇒ 25)
- 22 Return to previous screen
- 23 Select audio (⇒ 25)
- 24 Show Playback menu (⇒ 34)/Set the sleep timer
 - ① Press and hold [-SLEEP].
 - ② While "SLEEP * *" is displayed, press [-SLEEP] several times to select the time (in minutes).
 - Timer selection is up to 120 minutes.
 - Select "OFF" when cancelling the setting.
 - To confirm the remaining time
Press and hold the button again.

Main unit (Front)

e.g., **BT735**

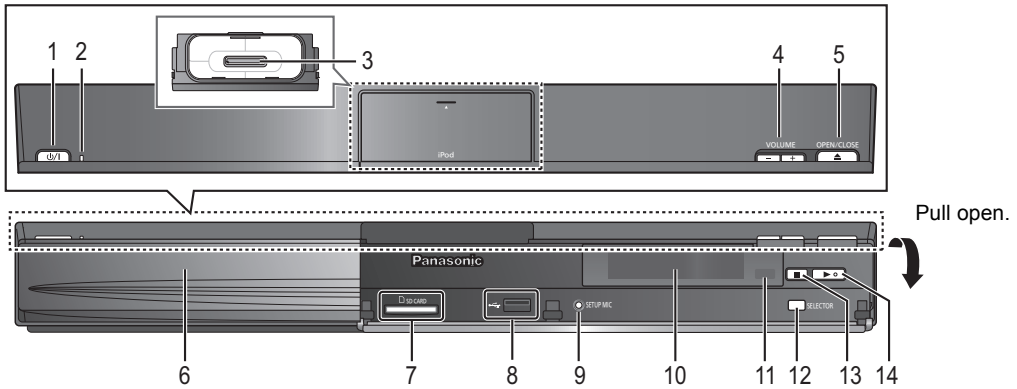

- 1 **Standby/on switch** (⏻/⏻) (⇒ 19)
Press to switch the unit from on to standby mode or vice versa. In standby mode, the unit is still consuming a small amount of power.
- 2 **Power indicator**
The indicator lights when this unit is turned on.
- 3 **Connect iPod/iPhone** (⇒ 32)
- 4 **Adjust the volume of the main unit**
- 5 **Open or close the disc tray** (⇒ 22)
- 6 **Disc tray**
- 7 **SD card slot** (⇒ 22)
- 8 **USB port** (⇒ 22)
- 9 **BT735 BT330 Connect Auto speaker setup microphone**
- 10 **Display (FL display)**
• “SRD” (SURROUND) lights when sound is output to the surround speakers.
- 11 **Remote control signal sensor**
Distance: within approx. 7 m.
Angle: Approx. 20° up and down, 30° left and right
- 12 **Select the source** (⇒ 23)
- 13 **Stop** (⇒ 25)
- 14 **Start play** (⇒ 25)

■ If the front cover comes off

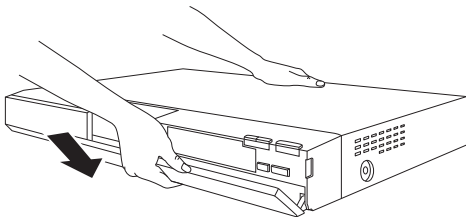

- ① Hold rear side of main unit by one hand and match up left or right side protruding hook on the cover first with the corresponding slot on the unit.
- ② Push the hook firmly towards the unit until it clicks into place. Then push the succeeding hooks one by one until all have clicked into place.
- ③ Check that the cover now moves correctly.
• If it does not, remove it and repeat the above procedure.

Main unit (Rear)

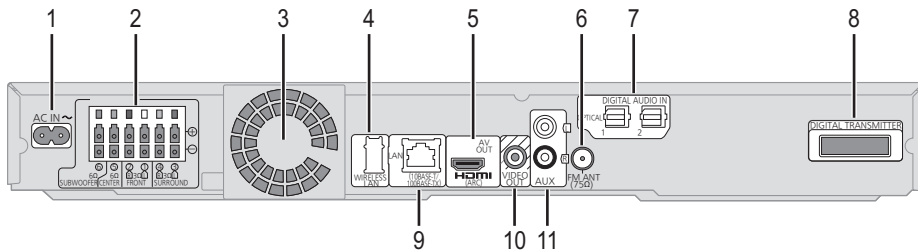

- 1 **AC IN terminal** (⇒ 18)
- 2 **Speaker terminals** (⇒ 15)
- 3 **Cooling fan**
- 4 **USB port for optional wireless adaptor** (⇒ 18)
- 5 **HDMI AV OUT terminal** (⇒ 17)
- 6 **FM radio antenna terminal** (⇒ 15)
- 7 **DIGITAL AUDIO IN terminals** (⇒ 16 , 17)
Terminal 1 is designated for connection with the TV.
Terminal 2 can be used with equipment other than the STB.
- 8 **Digital transmitter dock** (⇒ 14)
Connect a digital transmitter when using an optional wireless system.
- 9 **LAN port** (⇒ 18)
- 10 **VIDEO OUT terminal** (⇒ 16)
- 11 **AUX terminal** (⇒ 16)

Playable discs/Cards/USB devices

Type	Logo examples	Type detail	Playable contents*
BD		BD-Video	Video
		BD-RE	Video JPEG
		BD-R	Video DivX®
DVD		DVD-Video	Video
		DVD-RAM	Video AVCHD JPEG
		DVD-R	Video AVCHD
		DVD-R DL	DivX MP3 JPEG
		DVD-RW	Video AVCHD
	—	+R/+RW/+R DL	
CD		Music CD	Music [CD-DA]
	—	CD-R CD-RW	DivX Music [CD-DA] MP3 JPEG
SD		SD Memory Card (8 MB to 2 GB) (Includes miniSD Card and microSD Card) SDHC Memory Card (4 GB to 32 GB) (Includes microSDHC Card) SDXC Memory Card (48 GB, 64 GB) (Includes microSDXC Card) (as of December 2009)	MPEG2 AVCHD JPEG
USB	—	USB device (up to 128 GB)	DivX MP3 JPEG

* See page 11, 46–47 for more information on the types of content that can be played.

■ Discs that cannot be played in this unit

Any other disc that is not specifically supported or previously described.

- 2.6 GB and 5.2 GB DVD-RAM
- DVD-RAM that cannot be removed from cartridge
- Super Audio CD
- Photo CD
- DVD-Audio
- Video CD and Super Video CD
- WMA discs
- HD DVD

■ Region management information

BD-Video

This unit plays BD-Video marked with labels containing the region code "B".

Example:



DVD-Video

This unit plays DVD-Video marked with labels containing the region number "2" or "ALL".

Example:



■ Finalize

DVD-R/RW/R DL, +R/+RW/+R DL and CD-R/RW recorded by a recorder, etc. needs to be finalized by the recorder to play on this unit. Please refer to the recorder's instructions.

■ BD-Video

This unit supports high bit rate audio (Dolby Digital Plus, Dolby TrueHD, DTS-HD High Resolution Audio and DTS-HD Master Audio) adopted in BD-Video. In order to enjoy these audio formats, refer to page 38.

■ Music CD

Operation and sound quality of CDs that do not conform to CD-DA specifications (copy control CDs, etc.) cannot be guaranteed.

■ SD card

- MiniSD Cards, microSD Cards, microSDHC Cards and microSDXC Cards can be used, but must be used with an adaptor card. These are usually supplied with such cards, or otherwise customer provided.
- Keep the Memory Card out of reach of children to prevent swallowing.
- To protect the card's contents, move the record prevention tab (on the SD card) to "LOCK".
- This unit is compatible with SD Memory Cards that meet SD Card Specifications FAT12 and FAT16 formats, as well as SDHC Memory Cards in FAT32 format (Does not support long file name.) and SDXC Memory Cards in exFAT.
- If the SD card is used with incompatible computers or devices, recorded contents may be erased due to the card being formatted etc.
- Useable memory may be slightly less than the card capacity.



■ USB device

- This unit supports connecting a USB memory, digital camera and video camera produced by Panasonic, etc. It is not warranted that all USB devices will work with this unit.
- This unit does not support USB device charging.
- FAT12, FAT16 and FAT32 file systems are supported.
- This unit supports USB 2.0 High Speed.



- It may not be possible to play the above media in some cases due to the type of media, the condition of the recording, the recording method and how the files were created.
- The producers of the disc can control how discs are played. So you may not always be able to control play as described in these operating instructions. Read the disc's instructions carefully.

STEP 1: Preparing the speakers

Assembling the speakers

BT735 BT330

Caution

- Do not stand on the base. Be cautious when children are near.
- When carrying speakers, hold the stand and base parts.

Preparation

- To prevent damage or scratches, lay down a soft cloth and perform assembly on it.
- For wall mount, refer to page 42.
- Keep the screws out of reach of children to prevent swallowing.

BT735

- 2 Front speakers
- 2 Surround speakers
- 4 Stands (with cables)
- 4 Bases
- 8 Screws A
- 4 Screws B

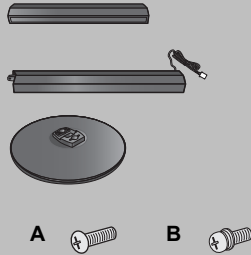

BT330

- 2 Front speakers
- 2 Stands (with cables)
- 2 Bases
- 8 Screws

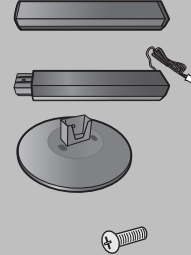

BT735

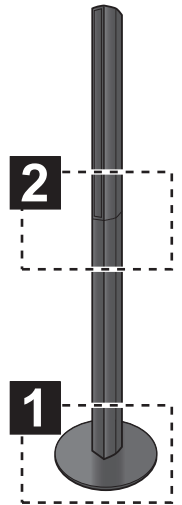
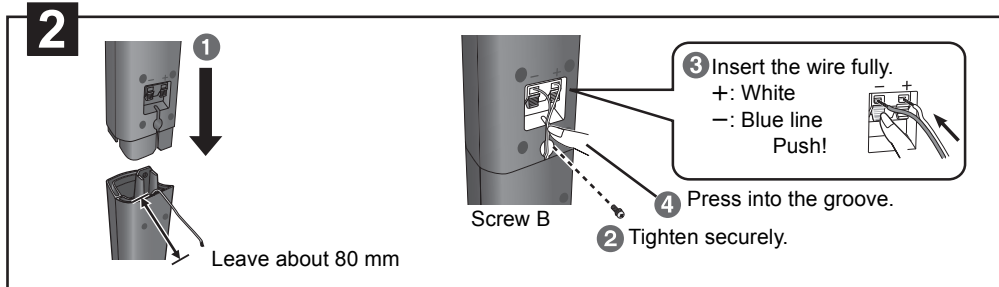
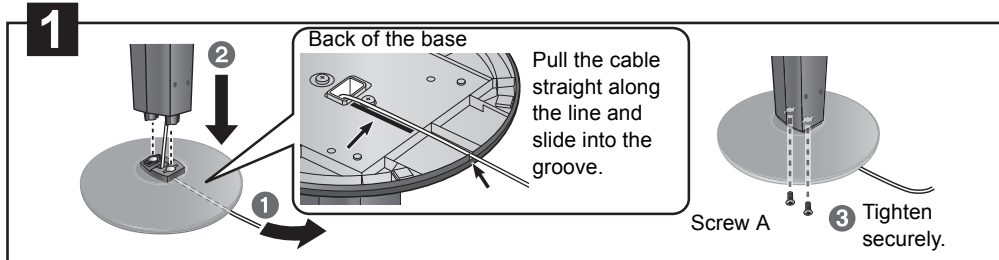

BT330

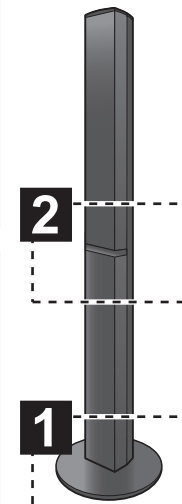
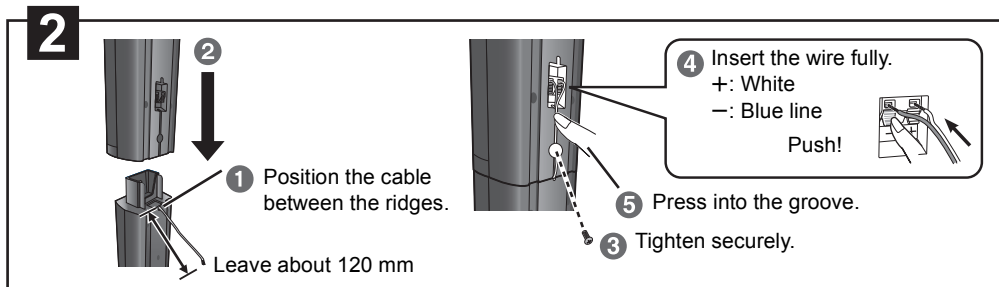
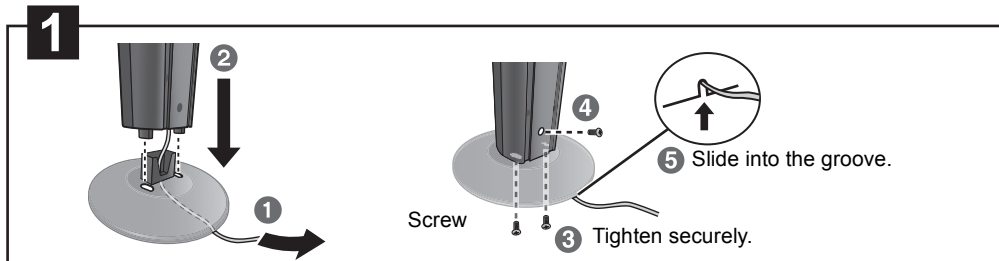

- 3** Use of the speaker cable stickers is convenient when making cable connections.
e.g. Front speaker (L)

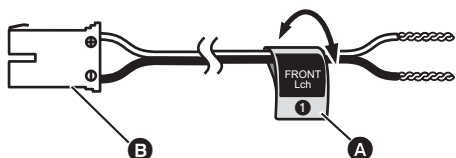

- A** Speaker cable sticker (included)
B Connector

Speaker cable sticker	Colour
① FRONT (L)	WHITE
② FRONT (R)	RED
③ SURROUND (L)	BLUE
④ SURROUND (R)	GREY
⑤ CENTRE	GREEN
⑥ SUBWOOFER	PURPLE

Be sure to match the number on each sticker with the connector colour.

- 4** Connecting the speaker cables. Insert the wire fully, taking care not to insert beyond the wire insulation.
e.g. Surround speaker **BT230**

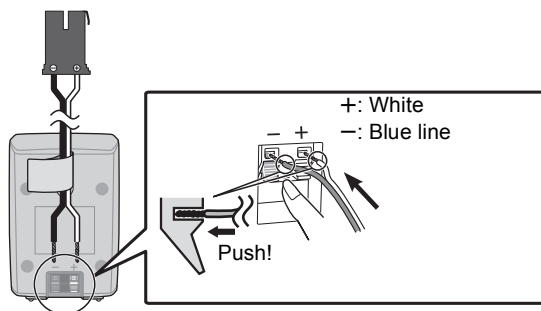

- Be careful not to cross (short-circuit) or reverse the polarity of the speaker wires as doing so may damage the speakers.
- Don't use a front speaker as a surround speaker or vice versa. Verify the type of speaker with the label on the rear of the speaker before connecting the appropriate cable.
- To avoid injury by falling or dropping the speaker, place the speaker cables with care not to stumble or hook.
- Do not hold the speaker in one hand to avoid injury by dropping the speaker when carrying.

Speaker assembly option

BT330

Thread the speaker cable through the base.

Attach the speaker.

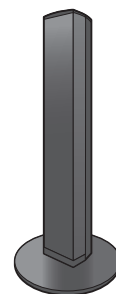

BT735 **BT330**

Preventing the speakers from falling

- Consult a qualified housing contractor concerning the appropriate procedure when attaching to a concrete wall or a surface that may not have strong enough support. Improper attachment may result in damage to the wall or speakers.
- Use a string of less than \varnothing 2.0 mm, which is capable of supporting over 10 kg.

e.g., **BT735**

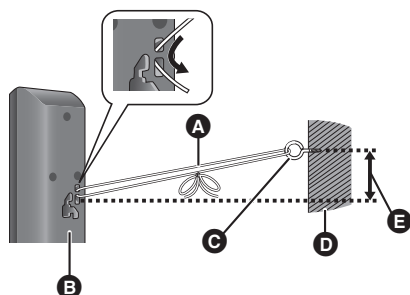

- A** String (not included)
Thread from the wall to the speaker and tie tightly.
- B** Rear of the speaker
- C** Screw eye (not included)
- D** Wall
- E** Approx. 150 mm

STEP 2: Positioning

Caution

- The main unit and supplied speakers are to be used only as indicated in this setup. Failure to do so may lead to damage to the amplifier and/or the speakers, and may result in the risk of fire. Consult a qualified service person if damage has occurred or if you experience a sudden change in performance.
- Do not attempt to attach these speakers to walls using methods other than those described in this manual.
- Do not touch the front netted area of the speakers. Hold by the sides.

How you set up your speakers can affect the bass and the sound field.

Setup example

Place the front, centre, surround speakers at approximately the same distance from the seating position. The angles in the diagram are approximate.

BT735 **BT330**

Using "Auto Speaker Setup" (⇒ 19) is a convenient way to get the ideal surround sound from your speakers when you are unable to place them.



- Keep your speakers at least 10 mm away from the system for proper ventilation.

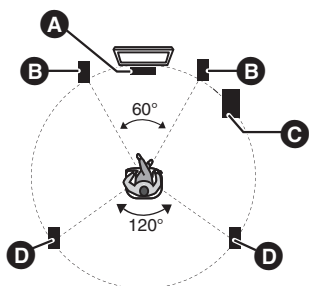

- A** Centre speaker
Put on a rack or shelf. Vibration caused by the speaker can disrupt the picture if it is placed directly on the TV.
- B** Front speakers
- C** Subwoofer
- D** Surround speakers
 - Place the speakers at the same height or higher than ear level.



You can enjoy surround speaker sound wirelessly when you use the optional Panasonic wireless accessory (SH-FX71).

For more details, refer to the operating instructions for the optional wireless system.



- **Use only supplied speakers**
Using other speakers can damage the unit, and sound quality will be negatively affected.
- You can damage your speakers and shorten their useful life if you play sound at high levels over extended periods.
- **Positioning speakers in front**
It is possible to locate all the speakers in front of the listening position. However, the optimal surround sound effect may not be obtainable.
- Place speakers on flat secure bases.
- Placing speakers too close to floors, walls, and corners can result in excessive bass. Cover walls and windows with thick curtains.
- For optional wall mount, refer to page 42.

■ If irregular colouring occurs on your TV, turn the TV off for about 30 minutes.

If it persists, move the speakers further away from the TV.

■ Upgrade your system to 7.1-channel system

The main unit is designed to enjoy the 7.1ch surround sound. By connecting 2 units of the Panasonic wireless system SH-FX71 with 4 speakers, more theatre-like effect can be available.

Necessary equipment:

- 2 optional wireless systems (SH-FX71)
- 2 additional speakers
[Impedance: 3 Ω to 6 Ω, Speaker input power: 100 W (Min)]

For more details, refer to the operating instructions for the optional wireless system.

STEP 3: Connections

Turn off all equipment before connection and read the appropriate operating instructions.
Do not connect the AC mains lead until all other connections are complete.

Speaker cable connection

Connect to the terminals of the same colour.

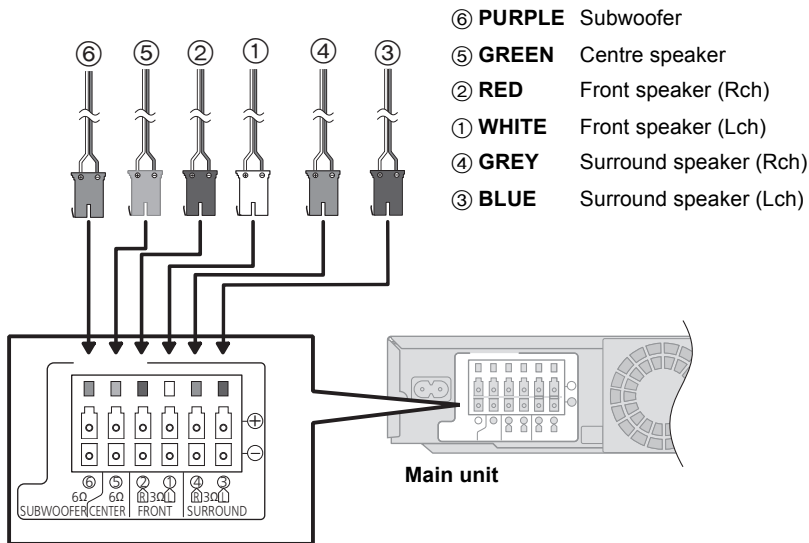

When using the optional wireless system, do not attempt to connect any extra surround or surround back speakers to the main unit.

Radio antenna connection

Using an indoor antenna

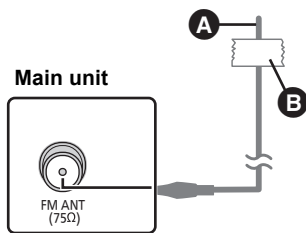

- A **FM indoor antenna** (included)
- B **Adhesive tape**
Affix this end of the antenna where reception is best.

Using an outdoor antenna

Use outdoor antenna if FM radio reception is poor.

e.g.,

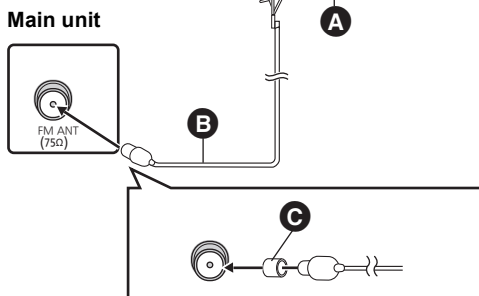

- A **FM outdoor antenna** [Using a TV antenna (not included)]
The antenna should be installed by a competent technician.
- B **75 Ω coaxial cable** (not included)
- C **Antenna plug adaptor** (United Kingdom and Republic of Ireland only)

• Keep the adaptor out of reach of children to prevent swallowing.

Connection to a TV

The basic connection is shown in the included Easy Setting Guide, however, there are more connection examples to optimize your system setting.



Do not make the video connections through the VCR.

- Due to copy guard protection, the picture may not be displayed properly.
- Turn off all equipment before connection.

OPTICAL IN

- After making the digital audio connection, make settings to suit the type of audio from your digital equipment (⇒ 30).

HDMI

The HDMI connection supports VIERA Link "HDAVI Control" (⇒ 31) when used with a compatible Panasonic TV.

- Please use High Speed HDMI Cables that have the HDMI logo (as shown on the cover). It is recommended that you use Panasonic's HDMI cable. When outputting 1080p signal, please use HDMI cables 5.0 meters or less.
Recommended part number:
RP-CDHS15 (1.5 m), RP-CDHS30 (3.0 m),
RP-CDHS50 (5.0 m), etc.

Basic connection

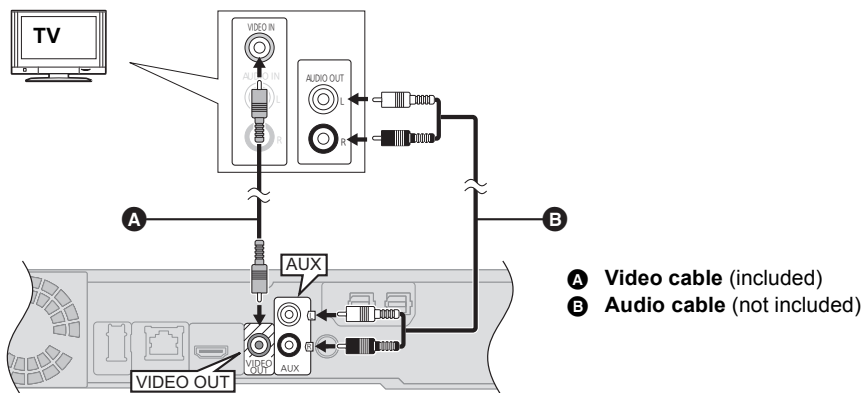

- To enjoy TV audio from this home theatre system's speakers, select "AUX (TV)" as a source (⇒ 23).

Connection for the better audio

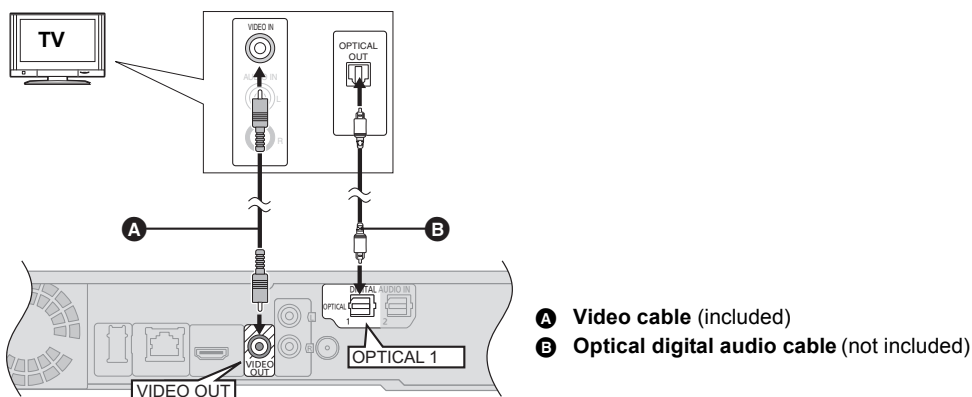

- To enjoy TV audio from this home theatre system's speakers, select "DIGITAL IN 1 (TV)" or "D-IN 1" as a source.

e.g.,

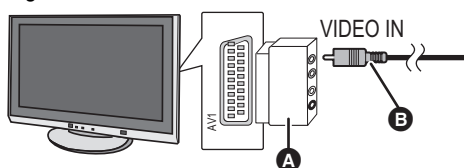

If the TV does not have a VIDEO IN terminal, connect using a Scart adaptor (Scart—VIDEO IN).

Connection for the best picture and audio

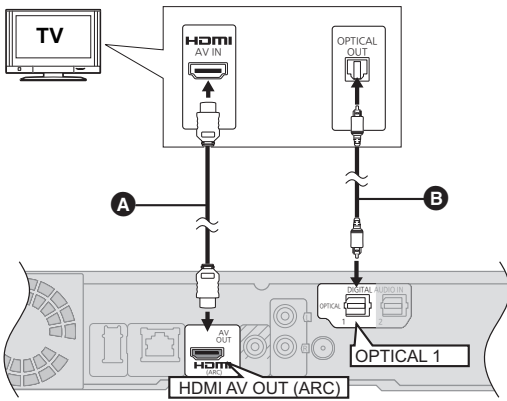

- A** HDMI cable (not included)
- B** Optical digital audio cable (not included)
 - For the TV audio, an audio cable (not included) can be also used by connecting the AUX terminal with the AUDIO OUT terminal on the TV.



- To enjoy TV audio from this home theatre system's speakers, select "DIGITAL IN 1 (TV)" or "D-IN 1" as a source (⇒ 23).

ARC (Audio Return Channel)

(Available when using an ARC compatible TV)

With this function it is possible to receive the digital audio signal from the TV without connecting any other audio cables.

- Select "ARC (TV)" as the audio input source (⇒ 23)
- Refer to the operating instructions of the TV for the settings to output digital audio.

Connection with Set Top Box, etc.

Refer to the operating instructions of the respective devices for the optimal connections.

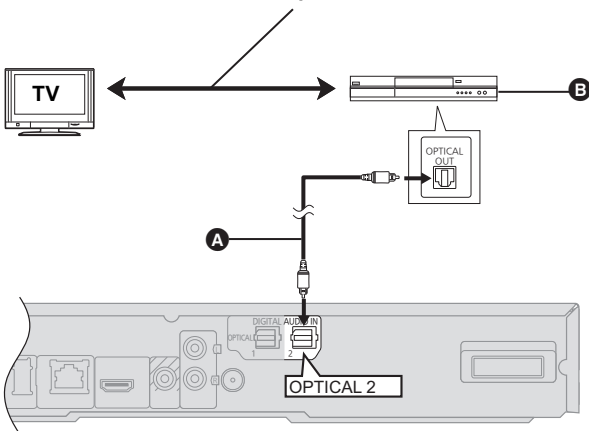

- A** Optical digital audio cable (not included)
- B** Set Top Box, cable TV, VCR, DVD recorder, etc.



- To enjoy TV audio from this home theatre system's speakers, select "DIGITAL IN 2 (CABLE/SAT)" or "D-IN 2" as a source (⇒ 23).

NECESSARY SETTINGS

- "HDMI Audio Output" : "Off" (⇒ 39)

Connection to a broadband network

The following services can be used when this unit is connected to broadband.

- Firmware can be updated (⇒ 21)
- You can enjoy the BD-Live (⇒ 26)
- You can enjoy VIERA CAST (⇒ 34)
- DLNA feature (⇒ 36)

■ Using LAN (ethernet) cable

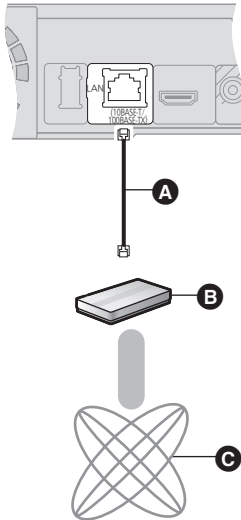

- A** LAN Cable [Straight] (not included)
- B** Broadband router, etc.
- C** Internet

- Use shielded LAN cables when connecting to peripheral devices.
- Inserting any cable other than a LAN cable in the LAN terminal can damage the unit.

For details about connection method, refer to the instructions supplied with the connected equipment.

- The unit is not compatible with public wireless LAN services (Hotspot etc.) provided in airports, stations, cafes etc.

■ Using Wireless LAN Adaptor (optional)

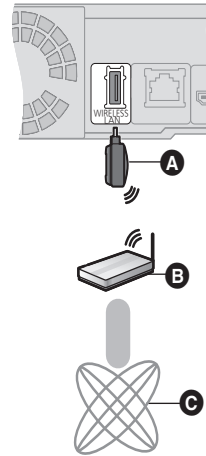

- Only the Wireless LAN Adaptor DY-WL10 (optional) can be used.

- A** Wireless LAN Adaptor
- B** Wireless router (Access point), etc.
- C** Internet

- Read the operating instructions for the Wireless LAN Adaptor DY-WL10 (optional) thoroughly when using it.
- For up to date compatibility information on your Wireless router (Access Point) refer to <http://panasonic.jp/support/global/cs/>

STEP 4: AC mains lead connection

For the United Kingdom and Republic of Ireland only

BE SURE TO READ THE CAUTION FOR THE AC MAINS LEAD ON PAGE 4 BEFORE CONNECTION.

- **Connect only after all other connections are complete.**
- The main unit consumes a small amount of AC power, even when it is turned off (When the "Quick Start" setting is "Off", **BT735** **BT330**: approx. 0.1 W, **BT230**: approx. 0.2 W). In the interest of power conservation, if you will not be using this unit for a long time, unplug it from the household mains socket.
- Do not use any other AC mains lead except the supplied one.

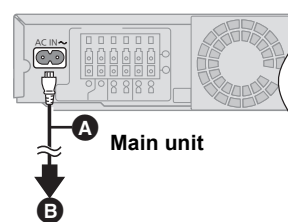

- A** AC mains lead (included)
- B** To a household mains socket

STEP 5: Smart setup / Easy setup

The Smart setup/Easy setup assists you to make necessary settings.

Follow the on-screen prompts to make basic settings for the system.

BT735 BT330: Smart setup

BT230: Easy setup

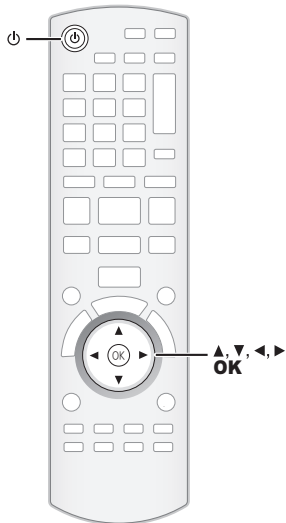

Preparation

- Turn on your TV and select the appropriate video input mode (e.g., VIDEO 1, AV 1, HDMI, etc.) to suit the connections to this unit.
- **BT735 BT330**: Place the Auto speaker setup microphone at the actual seating position. (At ear level when seated.)

e.g., **BT735**

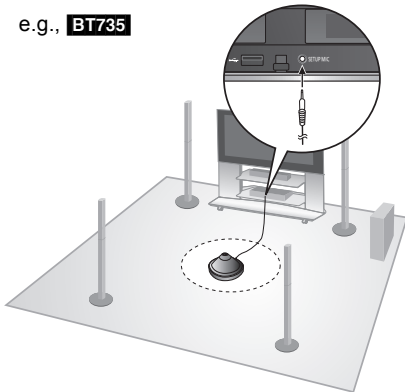

- Keep as quiet as possible during the Auto speaker setup. Excessive background noise may lead to incorrect settings.
- The speakers output loud test signals during setup.
- After the Smart setup is completed, unplug the Auto speaker setup microphone and keep it for future use.

- 1 Press [⏻].
- 2 Follow the on-screen instructions and make the settings with [▲, ▼, ◀, ▶] and press [OK].

Language

Select the language used on menu screen.

TV Aspect

Select the aspect to suit your TV and preference.

Wireless System

If a digital transmitter is inserted, it is required to specify the current settings.

Speakers position

Specify the positioning of the surround speakers.

BT230: Speaker check

Check if the connection to each speaker is valid.

BT735 BT330: Auto Speaker Setup

Adjust the speaker output level automatically.

Speaker Output

Make surround sound setting for speaker output.

Cinema Surround

The function creates the sound of virtual speakers to enhance the realistic surround feeling as if the sound comes from all directions.

(Speakers position: Surround Layout only)

(Effective when playing video with 5.1/7.1ch audio)

TV Audio

Select the audio input connection from your TV, [item with "(TV)"].

Quick Start

Speed of startup from standby mode is increased.

- 3 Press [OK] several times to finish the "Smart setup" or "Easy setup".

After completing "Smart setup" or "Easy setup", you can perform "Network Easy Setting".



- You can perform this setup anytime by selecting "Smart setup" or "Easy setup" in the Setup menu. (⇒ 40)
- Language and TV Aspect settings are automatically retrieved if this unit is connected to a Panasonic TV (VIERA) supporting HDAVI Control 2 or later via an HDMI cable.

Network Easy Setting

Select “Wired” or “Wireless” and press [OK].

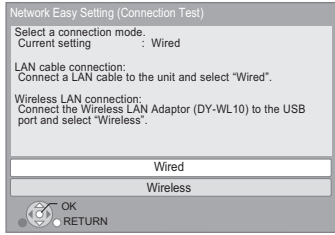

■ “Wired” connection

Follow the on-screen instructions to make your connection settings.

- When you experience problems (⇒ right)

■ “Wireless” connection

If you select “Wireless” and “Wireless LAN Adaptor is not connected.” is displayed, check that the Wireless LAN Adaptor is fully inserted. Alternatively, disconnect and reconnect it. If there is still no change in the display, consult your dealer for advice.

Select “WPS (PUSH button)” or “Search for access point” and then follow the on-screen instructions and make the settings.

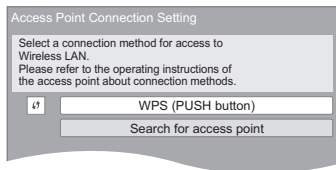

WPS (PUSH button):

If your Wireless router (Access point) supports WPS (PUSH button), you can easily perform the settings by pressing WPS button on it.

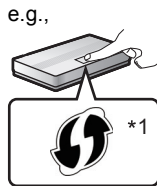

WPS (Wi-Fi Protected Setup) is a standard that facilitates settings relating to the connection and security of wireless LAN devices.

- ① Press WPS button or corresponding button of Wireless router (Access point) until the lamp starts flashing.
 - For details, refer to the operating instruction of Wireless router (Access point).
- ② Press [OK].

*1 Wi-Fi Protected Setup-compatible Wireless router (Access point) may have the mark.

Search for access point:

Available wireless routers (Access points) are searched and listed. You can select the one to use from the list.

- ① Press [▲, ▼] to select SSID*2 of Wireless router (Access point) you want to connect with. Then press [OPTION] to show information of the selected router, make a note of the authentication and encryption type.

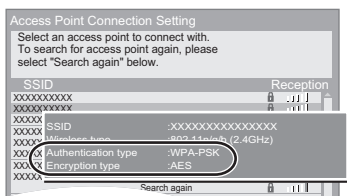

- If you can not find the SSID*2, select “Search again”.

- ② Press [RETURN] and then press [OK]. Then select an item on the following screen which corresponds to the authentication type noted down in step ① (⇒ left).

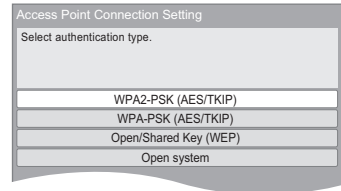

Follow the on-screen instructions to make the settings.
 • Input your encryption key code in “Encryption Key” supplied with your Wireless router (Access point).

When you experience problems with settings

Access Point Connection Setting

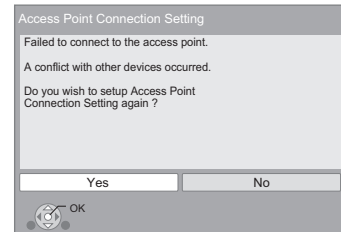

Display	Check the following
A conflict with another device occurred.	<ul style="list-style-type: none"> • Please wait a few moments, and then try again.
A time out error occurred.	<ul style="list-style-type: none"> • Setting of the Wireless router (Access point) for MAC Address etc. • The signal may be weak. Using the USB extension cable supplied with the Wireless LAN Adaptor, adjust the position of the Wireless LAN Adaptor. • The SSID*2 and the encryption key of the Wireless router (Access point). • Please wait a few moments, and then try again.
An authentication error or a time out error occurred.	
A device error occurred.	<ul style="list-style-type: none"> • Connection of Wireless LAN Adaptor If there is no improvement in symptom, consult your dealer.

Network Easy Setting (Connection Test)

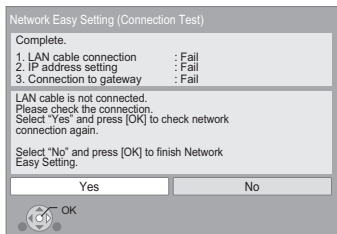

Display	Check the following
1. LAN cable connection or Connection to access point :Fail 2. IP address setting :Fail 3. Connection to gateway :Fail	<ul style="list-style-type: none"> ● Connection of the LAN cables (⇒ 18)
1. LAN cable connection or Connection to access point :Pass 2. IP address setting :Fail 3. Connection to gateway :Fail	<ul style="list-style-type: none"> ● Connection and settings of the hub and router ● Settings of "IP Address / DNS Settings" (⇒ 40)
1. LAN cable connection or Connection to access point :Pass 2. IP address setting :Home network available 3. Connection to gateway :Fail	
1. LAN cable connection or Connection to access point :Pass 2. IP address setting :Pass 3. Connection to gateway :Fail	

Network Easy Setting (Internet Connection Test)

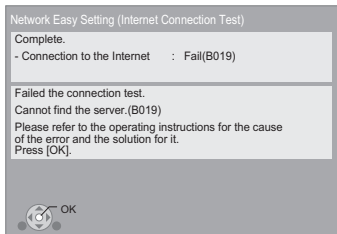

Display	Check the following
Cannot find the server. (B019)	<ul style="list-style-type: none"> ● "Primary DNS" and "Secondary DNS" settings of "IP Address / DNS Settings" (⇒ 40)
Failed to connect to the server. (B020)	<ul style="list-style-type: none"> ● The server may be busy or the service may have been suspended. Please wait a few moments, and then try again. ● Settings of "Proxy Server Settings" (⇒ 40) and the router



- Refer to the operating instructions of the hub or router.
- You can perform this setup anytime by selecting "Network Easy Setting" in the Setup menu. (⇒ 40)
- You can redo these settings individually using "Network Settings". (⇒ 40)
- Do not connect to a wireless network for which you do not have usage rights. Wireless networks for which you do not have usage rights (SSID*2) may appear during the automatic search for a wireless network environment. However, if you connect, there is a risk that it will be regarded as illegal access.

- After performing network settings on this unit, the settings (encryption level, etc.) of the Wireless router (Access point) might change. When you have trouble getting online on your PC, perform the network settings of your PC in accordance with the settings of Wireless router (Access point).

- *2 This is a name given to identify specific networks among wireless LANs. When the SSID is the same in two devices, data can be transmitted between them.

Firmware updating

Occasionally, Panasonic may release updated firmware for this unit that may add or improve the way a feature operates. These updates are available free of charge.

This unit is capable of checking the firmware automatically when connected to the Internet via a broadband connection. When a new firmware version is available, the following screen is displayed.

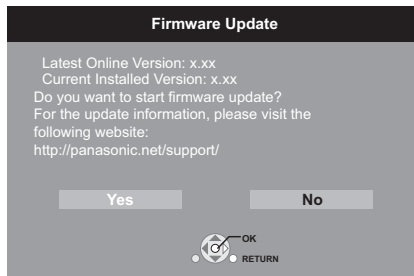

If downloading on this unit fails or this unit is not connected to the Internet, then you can download the latest firmware from the following website and burn it to a CD-R to update the firmware.

<http://panasonic.jp/support/global/cs/>
(This site is in English only.)

To show the firmware version on this unit. (⇒ 40, "System Information")

DO NOT DISCONNECT the unit from the AC power or perform any operation while the update takes place.

After the firmware is installed, "FINISH" will be displayed on the unit's display. Unit will restart and the following screen will be displayed.

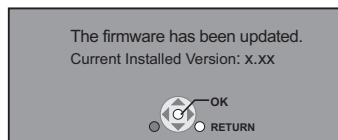

- You can perform update anytime by selecting "Firmware Update" in the Setup menu. (⇒ 40)
- Downloading will require several minutes. It may take longer or may not work properly depending on the connection environment.
- If you do not want to check for the latest firmware version, set "Automatic Update Check" to "Off". (⇒ 40)

STEP 6:

Reprogramming the remote control

When other Panasonic products respond to this remote control

Change "Remote Control" (⇒ 40) on the main unit and the remote control (the two must match) if you place other Panasonic products close together and it responds to this remote control.

To change the code on the main unit.

- 1 While stopped, press [START].
- 2 Press [▲, ▼] to select "To Others" and press [OK].
- 3 Press [▲, ▼] to select "Setup" and press [OK].
- 4 Press [▲, ▼] to select "General" and press [OK].
- 5 Press [▲, ▼] to select "Remote Control" and press [OK].
- 6 Press [▲, ▼] to select the code (1 or 2) and press [OK].

To change the code on the remote control.

- 1 While pressing [OK]
Press and hold the numbered button (1 or 2), which has the same number you selected in the step 6 for more than 5 seconds.
- 2 Press [OK].

Inserting or removing a media

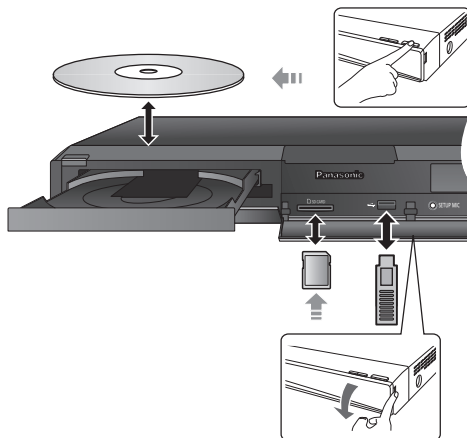

- When inserting a media, ensure that it is facing the right way up.
- While the reading indicator is displayed, do not turn off the unit or remove the media. Such action may result in loss of the media's contents.
- When removing the SD card, press on the centre of the card and pull it straight out.
- If you connect a Panasonic product with a USB connection cable, setup screen may be displayed on connected equipment. For details, refer to the instructions for the connected equipment.

■ To switch sources

Press [BD/SD] or [EXT-IN] to select "BD/DVD", "SD" or "USB".

- If a media is inserted while the unit is stopped, the source switches automatically depending on the inserted media.

START menu

Major functions of this unit can be operated from the START menu.

- 1 Press [START].
- 2 Press [▲, ▼] to select the item and press [OK].

e.g., BD-Video



Playback Viewing Picture		Play back the contents.
Top Menu		(⇒ 25)
Menu		(⇒ 25)
Network	Home Network (DLNA)	(⇒ 36)
	Internet Content	Displays the Home screen of the VIERA CAST (⇒ 34)
Input Selection		Switches to each source BD/DVD/CD SD card iPod FM Radio: To enjoy the FM radio (⇒ 29) USB device AUX*1: To enjoy TV broadcasts with this unit's speakers (⇒ 30) ARC*1: To enjoy TV broadcasts with this unit's speakers (⇒ 30) DIGITAL IN 1*1: To enjoy TV broadcasts with this unit's speakers (⇒ 30) *1 "(TV)" is displayed next to items set for TV AUDIO input. DIGITAL IN 2*2: To enjoy audio from other devices with this unit's speakers (⇒ 30) *2 "(CABLE/SAT)" is displayed next to DIGITAL IN when set for CABLE/SAT AUDIO input. To enjoy sound from the TV Select one source from either "AUX (TV)", "ARC (TV)" or "DIGITAL IN 1 (TV)".
Sound(Equalizer)		(⇒ 24)

To Others	Playlists: You can play playlists created on DVD-VR.
	Setup: (⇒ 37)
	Card Management: (⇒ 26)

To exit the screen
Press [START].

■ Selecting the source by the remote control

Button	Source
	BD/DVD or SD card (SD) (⇒ 25)
	iPod (IPOD) (⇒ 32)
	FM Radio (FM) (⇒ 29) AUX*1 (⇒ 30) USB (⇒ 25) ARC*1 (⇒ 30) DIGITAL IN 1*1 (D-IN 1) (⇒ 30) DIGITAL IN 2*2 (D-IN 2) (⇒ 30) *1 "(TV)" is displayed next to items set for TV AUDIO input. *2 "(CABLE/SAT)" is displayed next to DIGITAL IN when set for CABLE/SAT AUDIO input. To enjoy sound from the TV Select one source from either "AUX (TV)", "ARC (TV)" or "DIGITAL IN 1 (TV)".



- Items to be displayed may vary with the media.

Enjoying sound effects from all speakers

Enjoying surround sound effects

1 Press [SURROUND] several times to select the effect.

STANDARD

Sound is output as it was recorded/encoded.
Speaker output varies depending on the source.

MULTI-CH

You can enjoy sound from the front speakers, as well as the surround even when playing a 2-channel sound or non-surround sound.

MANUAL

- The selected effect will only be displayed on the main unit.

2 While "MANUAL" is displayed, press [◀, ▶] and select the desired effect.

DOLBY PL II MOVIE (Dolby Pro Logic II Movie)

Suitable for movie software, or the one recorded in Dolby Surround.
(except DivX)

DOLBY PL II MUSIC (Dolby Pro Logic II Music)

Adds 5.1-channel effects to stereo sources.
(except DivX)

7.1CH VS (7.1CH Virtual Surround)

You can enjoy 6.1/7.1-channel surround-like effect using 5.1-channel speakers.

S.SURROUND (Super Surround)

You can enjoy sound from all speakers with stereo sources.

2CH STEREO

You can play any source in stereo. Sound will be output to the front speakers and the subwoofer only.

■ Adjusting speaker level during play

- ① Press and hold [–CH SELECT] to activate the speaker setting mode.
- ② Press [–CH SELECT] several times to select the speaker. Each time you press the button:

L R → C → RS → RB* → LB* → LS → SW
↑

- * When the optional surround back speakers are connected.

L R: Front speaker (left and right: only the balance is adjustable.)

- Press [◀, ▶] to adjust the balance of the front speakers.

C: Centre speaker

RS: Surround speaker (right)

RB*: Surround back speaker (right)

LB*: Surround back speaker (left)

LS: Surround speaker (left)

SW: Subwoofer

- The channels not included in the playing audio will not be displayed (subwoofer is displayed even if it is not included).

- ③ Press [▲] (increase) or [▼] (decrease) to adjust the speaker level for each speaker.
–6 dB to +6 dB

■ Changing the sound modes

- ① Press [SOUND] several times to select the mode.
 - The selected mode will only be displayed on the main unit.
- ② While the selected mode is displayed Press [◀, ▶] and select the desired setting.

EQ: (Equalizer)

You can select sound quality settings.

FLAT

Cancel (no effect is added).

HEAVY

Adds punch to rock.

CLEAR

Clarifies higher sounds.

SOFT

For background music.

SUB W: (Subwoofer level)

You adjust the amount of base.

1 (Weakest effect) to 4 (Strongest effect)

- The setting you make is retained, and recalled every time you play the same type of source.

H.BASS

You can enhance low-frequency sound so that heavy bass sound can be heard clearly, even if the acoustics of your room are not optimal.

- The setting you make is retained, and recalled every time you play the same type of source.

C.FOCUS: (Centre focus)

(Effective when playing audio containing centre channel sound.)

You can make the sound of the centre speaker seem like it is coming from within the TV.

W.SRND: (Whisper-mode Surround)

You can enhance the surround effect for low volume sound. (Convenient for late night viewing.)



- The sound effects/modes may not be available or have no effect with some sources.
- You may experience a reduction in sound quality when these sound effects/modes are used with some sources. If this occurs, turn the sound effects/modes off.

Playing video contents

BD DVD CD SD USB

Preparation

Turn on the television and select the appropriate video input on the television.

1 Press [⏻] to turn on the unit.

2 Insert the media.

Play starts.

- If the menu is displayed, press [▲], [▼], [◀], [▶] to select the item and press [OK].
- If play does not start, press [▶] [PLAY].

■ To show menus

You can display Top Menu, DIRECT NAVIGATOR or Pop-up Menu.

Press [TOP MENU/DIRECT NAVIGATOR] or [POP-UP MENU].

- Press [▲], [▼], [◀], [▶] to select the item and press [OK].
- Pop-up menu also appears by pressing [OPTION] and selecting "Pop-up Menu".

■ To show the status messages

While playing, press [STATUS].

The status messages give you information about what is currently being played. Each time you press [STATUS], the information displayed will change.

e.g. BD-Video



- Signal from PAL discs is output as PAL. Signal from NTSC discs is output as "NTSC" or "PAL60". You can select "NTSC" or "PAL60" in "NTSC Contents Output" for NTSC discs. (⇒ 38)
- Depending on media and contents, the display may change or may not appear.
- DivX: Successive play is not possible.
- It is not possible to playback AVCHD and MPEG2 video which have been dragged and dropped, copied and pasted to the media.

Other operations during play

These functions may not work depending on the media and contents.

Stop

Press [■] [STOP].

The stopped position is memorised.

Resume play function

Press [▶] [PLAY] to restart from this position.

- The position is cleared if the tray is opened or you press [■] [STOP] several times to display "STOP" on unit's display.
- On BD-Video discs including BD-J (⇒ 49), the resume play function does not work.

Pause

Press [⏸] [PAUSE].

- Press [⏸] [PAUSE] again or [▶] [PLAY] to restart play.

Search/Slow-motion

Search

While playing, press [SEARCH ◀◀] or [SEARCH ▶▶].

- Music and MP3: The speed is fixed to a single step.

Slow-motion

While paused, press [SEARCH ◀◀] or [SEARCH ▶▶].

- BD-Video and AVCHD: Forward direction [SEARCH ▶▶] only.

The speed increases up to 5 steps.

- Press [▶] [PLAY] to revert to normal playback speed.

Skip

While playing or paused, press [SKIP ◀◀] or [SKIP ▶▶].

Skip to the title, chapter or track you want to play.

- Each press increases the number of skips.
- DivX: Backward direction [SKIP ◀◀] only.

Frame-by-frame

While paused, press [◀] (◀◀) or [▶] (▶▶).

- Press and hold to change in succession forward or backward.
- Press [▶] [PLAY] to revert to normal playback speed.
- BD-Video and AVCHD: Forward direction [▶] (▶▶) only.

Changing audio

Press [AUDIO].

You can change the audio channel number or soundtrack language (⇒ 47), etc.

Useful functions

1 Press [OPTION].

2 Select an item and press [OK].

While DIRECT NAVIGATOR screen is displayed

Properties	To display the titles properties (recording date, etc.)
Chapter View	To select the chapter
To Picture	Playing still pictures (⇒ 38)
Folder	To switch to another folder

While playing

Screen Aspect	When black bars are shown at the top, bottom, left, and right sides of the screen, you can enlarge the image to fill the screen.
Top Menu	To display Top Menu.
Pop-up Menu	To display Pop-up Menu.
Menu	To display Menu.

- Depending on the played contents if you perform “Screen Aspect”, there may be no effect.
- When “TV Aspect” (⇒ 39) is set to “4:3” or “4:3 Letterbox”, the “Zoom” effect is disabled.



- Depending on the media and contents, displayed items are different.

Enjoying BD-Live or BONUSVIEW in BD-Video

What is BONUSVIEW?

BONUSVIEW allows you to enjoy functions such as picture-in-picture or secondary audio etc.

What is BD-Live?

In addition to the BONUSVIEW function, BD-Live allows you to enjoy more functions such as subtitles, exclusive images and online games by connecting this unit to the Internet.

- The usable functions and the operating method may vary with each disc, please refer to the instructions on the disc and/or visit their website.

Playing picture-in-picture

To turn on/off secondary video
Press [PIP].

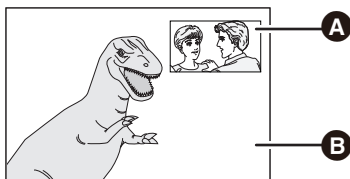

- A** Secondary video
- B** Primary video

To turn on/off secondary audio

- 1 Press [DISPLAY].
- 2 Press [▲, ▼] to select the “Disc” menu and press [▶].
- 3 Press [▲, ▼] to select the “Signal Type” menu and press [OK].
- 4 Press [▲, ▼] to select the “Soundtrack” under “Secondary Video” menu and press [▶].
- 5 Press [▲, ▼] to select the “On” or “Off”.
When “On” is selected, press [▶] and then press [▲, ▼] to select the language.
- 6 Press [RETURN] to exit.



- During search/slow-motion or frame-by-frame, only the primary video is displayed.
- When “BD-Video Secondary Audio” in “Digital Audio Output” is set to “Off”, secondary audio will not be played (⇒ 38).

Enjoying BD-Live discs with Internet

Some BD-Live content available on the Blu-ray discs may require an Internet account to be created in order to access the BD-Live content. Follow the screen display or instruction manual of the disc for information on acquiring an account.

1 Connect to the network. (⇒ 18)

2 Insert an SD card (with 1 GB or more free space). SD card is used as the local storage (⇒ 49).

3 Insert the disc.

■ Deleting data/Formatting SD cards

- 1 Insert an SD card.
- 2 Press [START].
- 3 Press [▲, ▼] to select “To Others” and press [OK].
- 4 Press [▲, ▼] to select “Card Management” and press [OK].
- 5 Press [▲, ▼] to select “BD-Video Data Erase” or “Format SD Card” and press [OK].

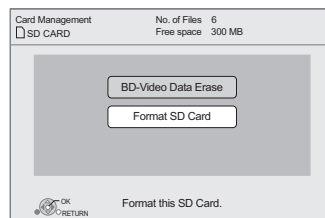

- 6 Press [◀, ▶] to select “Yes” and press [OK].
- 7 Press [◀, ▶] to select “Start” and press [OK].



- To use the above functions, it is recommended that you format the card on this unit. If the SD card you use is formatted, all data on the card will be erased. It cannot be recovered.
- “BD-Live Internet Access” may need to be changed for certain discs (⇒ 38).
- When discs supporting BD-Live are played back, the player or disc IDs may be sent to the content provider via the Internet.

ABOUT DIVX VIDEO:

DivX® is a digital video format created by DivX, Inc. This is an official DivX Certified device that plays DivX video. Visit www.divx.com for more information and software tools to convert your files into DivX video.

ABOUT DIVX VIDEO-ON-DEMAND:

This DivX Certified® device must be registered in order to play DivX Video-on-Demand (VOD) content.

To generate the registration code, locate the DivX VOD section in the device setup menu.

Go to vod.divx.com with this code to complete the registration process and learn more about DivX VOD.

- It is not possible to playback DivX VOD content recorded on the USB device.

Display the unit's registration code.

(⇒ 40, "DivX Registration" in "General")



- A** 10 alphanumeric characters

- After playing DivX VOD content for first time, the registration code is not displayed.
- If you purchase DivX VOD content using a registration code different from this unit's code, you will not be able to play this content. ("Authorisation Error." is displayed.)

Cancel the unit's registration.

(⇒ 40, "DivX Registration" in "General")

Press [◀, ▶] to select "Yes" in "DivX Registration".

Use the deregistration code to cancel the registration in www.divx.com.

Regarding DivX VOD content that can only be played a set number of times

Some DivX VOD content can only be played a set number of times. When you play this content, the remaining number of plays is displayed. You cannot play this content when the number of remaining plays is zero. ("Rental Expired." is displayed.)

- The remaining number of plays decreases each time a program is played. However, when playing from the point where play was previously stopped, the remaining number of plays does not decrease due to the resume play function.

■ Displaying subtitles text

You can display subtitles text on the DivX video disc on this unit.

This function has no relation to the subtitles specified in DivX standard specifications and has no clear standard. The operation might be different or it may not operate properly depending on the way the file was made or the state of this unit (playing, stopped, etc.).

Set "Subtitle" in "Disc" (⇒ 34)



- DivX video files that do not display "Text" do not contain subtitles text.
- If the subtitles text are not displayed correctly, try changing the language settings. (⇒ 38)

Playing music

DVD CD USB

(DVD-R/-R DL, music CD, CD-R/RW, USB device)

1 Insert a disc or USB device.

If the menu is displayed, press [▲, ▼] to select the item and press [OK].

2 Press [▲, ▼] to select the track and press [OK].

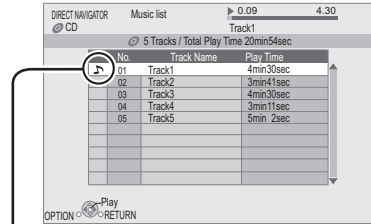

"🎵" indicates the track currently playing.

■ Playing a track in another folder

- ① While the "Music list" is displayed
Press [OPTION].
- ② Press [▲, ▼] to select "Select Folder" and press [OK].



- You cannot select folders that contain no compatible tracks.

Playing still pictures

BD DVD CD SD USB

(BD-RE, DVD-RAM/R-R DL, CD-R/RW, SD Card, USB device)

1 Insert a disc, SD card or USB device.

If the menu is displayed, press [**▲**, **▼**] to select the item and press [**OK**].

2 BD-RE, DVD-RAM

Press [**▲**, **▼**, **◀**, **▶**] to select the album and press [**OK**].

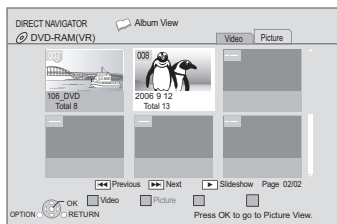

3 Press [**▲**, **▼**, **◀**, **▶**] to select the still picture and press [**OK**].

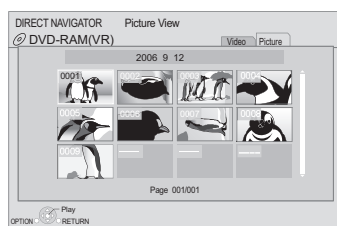

Press [**◀**, **▶**] to display the previous or next still picture.

To exit the screen

Press [**TOP MENU/DIRECT NAVIGATOR**].

■ To show the picture properties

While playing, press [**STATUS**] twice.

e.g. JPEG on DVD-RAM
Shooting date



To exit the screen

Press [**STATUS**].

Useful functions

1 Press [**OPTION**].

2 Select an item and press [**OK**].

While "Album View" or "Picture View" screen is displayed

Start Slideshow	You can display still pictures one by one at a constant interval.
Slideshow Setting	<p>Display Interval Change the display interval.</p> <p>Transition Effect Set display method.</p> <p>Repeat Play Repeat slideshow.</p> <p>Soundtrack Music files on an iPod/iPhone or a music CD or USB device can be played back as background music during the slideshow.</p> <p>Soundtrack Folder A folder to playback can be selected when a USB device with MP3 recorded is connected to this unit.</p> <p>Press [▲, ▼, ◀, ▶] to select "Set" and press [OK].</p>
Select Folder	To switch to another higher folder <ul style="list-style-type: none"> Only if there is a multiple number of higher folders recognizable
Folder	To select the still pictures in another folder
To Video	Playing video contents (⇒ 25)
To album view	To display album view.

While playing (except for slideshow)

Rotate RIGHT	Rotate the still picture.
Rotate LEFT	
Zoom out	Reduce the still picture <ul style="list-style-type: none"> This function is only available for small-sized still pictures.
Zoom in	Cancel "Zoom out"



- Depending on the media and contents, displayed items are different.
- When a still picture with large number of pixels is played, the display interval may become longer. Even if the setting is changed, the display interval may not become shorter.
- When a music CD, a USB device with MP3 recorded and an iPod/iPhone are inserted/connected to this unit, iPod/iPhone has a priority to be played back as background music.

Listening to the Radio

Presetting stations automatically

Up to 30 stations can be set.

- 1 Press [RADIO] to select “FM”.
- 2 Press [STATUS] to select the position to start the auto preset search.

LOWEST:

To begin auto preset with the lowest frequency (FM87.50).

CURRENT:

To begin auto preset with the current frequency.*

* To change the frequency, refer to “Presetting stations manually”.

- 3 Press and hold [OK].

Release the button when “AUTO” is displayed.

The tuner starts to preset all the stations it can receive into the channels in ascending order.



- “SET OK” is displayed when the stations are set, and the radio tunes to the last preset station.
- “ERROR” is displayed when automatic presetting is unsuccessful. Preset the stations manually.

Presetting stations manually

Preparation

Select a radio broadcast.

- ① Press [RADIO] to select “FM”.
 - ② Press [SEARCH◀◀] or [SEARCH▶▶] to select the frequency.
- To start automatic tuning, press and hold [SEARCH◀◀], [SEARCH▶▶] until the frequency starts scrolling. Tuning stops when a station is found.

- 1 While listening to the radio broadcast Press [OK].
- 2 While “P” is flashing on the display Press the numbered buttons to select a channel.

To select a 1-digit number

e.g., 1: [1] ⇒ [OK].

To select a 2-digit number

e.g., 12: [1] ⇒ [2]



- A station previously stored is overwritten when another station is stored in the same channel preset.

■ Display on the main unit

TUNED/STEREO: Displayed when receiving stereo broadcasting

TUNED: Displayed when receiving monaural broadcasting or monaural sound is selected.

Listening/confirming the preset channels

- 1 Press [RADIO] to select “FM”.
- 2 Press the numbered buttons to select the channel.

To select a 1-digit number

e.g., 1: [1] ⇒ [OK].

To select a 2-digit number

e.g., 12: [1] ⇒ [2].

Alternatively, press [∧, ∨] or [◀, ▶].

RDS broadcasting

If the station you are listening to is transmitting RDS signals, “RDS” will light up on the display.

While listening to the radio broadcast

Press [DISPLAY] to display the text data.

PS: Programme service

PTY: Programme type

OFF: Frequency display

PTY displays			
NEWS	VARIED	FINANCE	COUNTRY
AFFAIRS	POP M	CHILDREN	NATIONAL
INFO	ROCK M	SOCIAL A	OLDIES
SPORT	M.O.R. M*	RELIGION	FOLK M
EDUCATE	LIGHT M	PHONE IN	DOCUMENT
DRAMA	CLASSICS	TRAVEL	TEST
CULTURE	OTHER M	LEISURE	ALARM
SCIENCE	WEATHER	JAZZ	

* M.O.R. M=Middle of the road music

■ If noise is excessive

Press [AUDIO] to display “MONO”.

The sound becomes monaural.

Press the button again to cancel the mode. “AUTO ST” will be displayed on the main unit. Depending on the broadcast system, stereo or monaural will be selected.

“MONO” is also cancelled when you change the frequency.

- This setting can be preset for each broadcasting station.

Enjoying TV with unit's speakers

Preparation

Turn on your TV and select the appropriate audio input mode [AUX, ARC, D-IN 1 or D-IN 2] to suit the connections to this unit. (⇒ 23)

Surround sound effects

You can enhance stereo sources with surround sound effect.

- 1 Press [SURROUND] several times to select the effect.**
- 2 While "MANUAL" is displayed on the unit's display Press [◀, ▶] and select the desired effect.**

Surround modes to enjoy TV audio or stereo sources from all speakers:

- DOLBY PL II MOVIE
- DOLBY PL II MUSIC
- S.SURROUND
- Cinema Surround (⇒ 19)

For more detailed information on this operation, please refer to the "Enjoying surround sound effects" section on page 24.

Sound modes

You can adjust the mode depending on the source or situation.

- 1 Press [SOUND] several times to select the mode.**
- 2 While the selected mode is displayed on the unit's display Press [◀, ▶] and select the desired setting.**

For more detailed information on this operation, please refer to the "Changing the sound modes" section on page 24.

Making settings for digital audio input

Select to suit the type of audio from the DIGITAL AUDIO IN terminals on the main unit.

Press [EXT-IN] several times to select "D-IN 1" (DIGITAL IN 1) or "D-IN 2" (DIGITAL IN 2).

■ DIGITAL IN 1/DIGITAL IN 2

Press [AUDIO].

M1

M2

M1+M2 (stereo audio)

(Only works with Dolby Dual Mono)

- "M1" or "M2" is not available if "On" is selected in "Digital Audio Input". (⇒ 38)

■ DIGITAL IN 2

Press [STATUS].

CABLE/SAT AUDIO

Select when an HDMI connected STB is selected on the TV, "D-IN 2" input is automatically selected. (⇒ 31, "Setting the audio link with the STB").



- Audio that is input through the DIGITAL AUDIO IN or AUX terminals are not output from the HDMI AV OUT terminal.

Linked operations with the TV

(VIERA Link “HDAVI Control™”)

What is VIERA Link “HDAVI Control”?

VIERA Link “HDAVI Control” is a convenient function that offers linked operations of this unit, and a Panasonic TV (VIERA) under “HDAVI Control”. You can use this function by connecting the equipment with an HDMI cable. See the operating instructions for connected equipment for operational details.

Preparation

- ① Set “VIERA Link” to “On” (⇒ 39).
(The default setting is “On”).
- ② Set the “HDAVI Control” operations on the connected equipment (e.g., TV).
- ③ Turn on all “HDAVI Control” compatible equipment and select this unit’s input channel on the connected TV so that the “HDAVI Control” function works properly.
Also when the connection or settings are changed, repeat this procedure.

Setting the audio link

■ Setting the audio link with the TV

With the remote control;

- Select the actual TV audio connection on the main unit.
- ① Press [START] and press [▲, ▼] to select “To Others” and press [OK].
 - ② Press [▲, ▼] to select “Setup” and press [OK].
 - ③ Press [▲, ▼] to select “TV / Device Connection” and press [OK].
 - ④ Press [▲, ▼] to select “TV Audio Input”.
 - ⑤ Press [◀, ▶] to switch “AUX”, “ARC” or “DIGITAL IN 1”.
- Whenever the connection or settings are changed, reconfirm the points above.

■ Setting the audio link with the STB

With the remote control;

- Select the STB input channel on the TV.
- ① Press [EXT-IN] to select “D-IN 2”.
 - ② Press [STATUS] to select “CABLE/SAT AUDIO ON”.
- If the input channel of the STB on the TV is changed or if you want to change the device allocated for the linked operations, select “CABLE/SAT AUDIO OFF” in step ② above and then repeat steps ① to ②.



- VIERA Link “HDAVI Control”, based on the control functions provided by HDMI which is an industry standard known as HDMI CEC (Consumer Electronics Control), is a unique function that we have developed and added. As such, its operation with other manufacturers’ equipment that supports HDMI CEC cannot be guaranteed.
- This unit supports “HDAVI Control 5” function.
“HDAVI Control 5” is the newest standard (current as of December, 2009) for Panasonic’s HDAVI Control compatible equipment. This standard is compatible with Panasonic’s conventional HDAVI equipment.
- Please refer to individual manuals for other manufacturers’ equipment supporting VIERA Link function.

One touch play

You can turn on this unit and the TV, and start play with a single press of a button.

While the unit and the TV are in standby mode;
Press [▶ PLAY].

Speaker Selection

You can select whether audio is output from the unit’s speakers or the TV speakers by using the TV menu settings.

Home Cinema

This unit’s speakers are active.

- When this unit is in standby mode, changing the TV speakers to this unit’s speakers in the TV menu will automatically turn the unit on and select, “AUX”¹, “ARC”¹ or “D-IN 1” (DIGITAL IN 1)¹ as the source.
- You can control the volume setting using the volume or mute button on the TV’s remote control.
- If you turn off this unit, TV speakers will be automatically activated.

TV

TV speakers are active.

- The volume of this unit is set to “0”.
- Audio output is 2-channel audio.



- When switching between this unit’s speakers and TV speakers, the TV screen may be blank for several seconds.

Automatic input switching (Power on link)

When the following operations are performed, the television will automatically switch the input channel and display the corresponding action. When the television is off, the television will automatically turn on.

- When play starts on the unit
- When an action that uses the display screen is performed (e.g., DIRECT NAVIGATOR screen)
- BD-Video, DVD-Video:
When playback stops, the TV will automatically return to TV tuner mode.
- When you switch the TV input to TV tuner mode, this unit will automatically switch to “AUX”¹, “ARC”¹ or “D-IN 1” (DIGITAL IN 1)¹ or “D-IN 2” (DIGITAL IN 2)².
- This function does not work when the iPod/iPhone selector is chosen. (⇒ 33)

Automatic lip-sync function (for HDAVI Control 3 or later)

Delay between audio and video is automatically adjusted, enabling you to enjoy smooth audio for the picture. (⇒ 38, "Audio Delay")

- This function works only when "BD/DVD", "SD", "USB", "AUX"^{*1}, "ARC"^{*1}, "D-IN 1" (DIGITAL IN 1)^{*1} or "D-IN 2" (DIGITAL IN 2)^{*2} is selected as the source on this unit.

*1 "AUX", "ARC" or "D-IN 1" works depending on the setting in "Setting the audio link with the TV". (⇒ 31)

*2 "D-IN 2" works depending on the setting in "Setting the audio link with the STB". (⇒ 31)

Power Off Link

All connected equipment compatible with "HDAVI Control", including this unit, automatically turns off when you switch the television off.

Playing music continuously even after turning off the TV
(When the unit is connected to a Panasonic TV (VIERA) that supports HDAVI Control 2 or later.)

Select "Video" in "Power Off Link" (⇒ 39)

Easy control only with VIERA remote control

Only TV supports "HDAVI Control 2" or later

By using the TV remote control, you can play discs using the "Control Panel" and display the Top Menu or Pop-up Menu, etc.

- This works only during "BD/DVD", "SD" or "USB" playback and resume modes.

1 Press [OPTION].

e.g. BD-Video

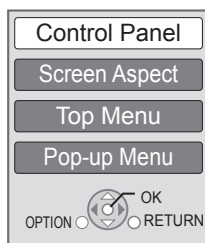

2 Select an item and press [OK].

- The OPTION menu may not appear while the Top Menu for BD-Video or DVD-Video is displayed.



- The buttons that you can use for this unit vary depending on the TV. For details, refer to the operating instructions of the TV.
- The operation of this unit may be interrupted when you press incompatible buttons on the TV remote control.
- Depending on the menu, some button operations cannot be performed from the TV's remote control.

Using the iPod/iPhone

iPod/iPhone Connection

Preparation

- Before connecting/disconnecting the iPod/iPhone, turn the main unit off or reduce the volume of the main unit to its minimum.
- Make sure that the video cable connection is made to view photos/videos from the iPod/iPhone.

- 1 Push Δ to open the iPod/iPhone lid.
- 2 Connect the iPod/iPhone (not included) firmly.

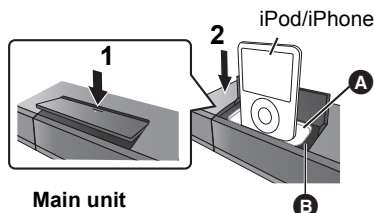

- A Dock adapter (not included)
 - Attach the dock adapter until firmly fitting into the dock. The adapter should be supplied with your iPod/iPhone for the stable use. If you need an adapter, consult your iPod/iPhone dealer.
- B Dock for iPod/iPhone



About recharging the battery

- iPod/iPhone will start recharging regardless of whether this unit is on or off.
- "IPOD *" will be shown on the main unit's display during iPod/iPhone charging in main unit standby mode.
- Once fully recharged, additional recharging will not occur.

Compatible iPod/iPhone (as of December 2009)

- Compatibility depends on the software version of your iPod/iPhone.

Name	Memory size
iPhone 3GS	16 GB, 32 GB
iPhone 3G	8 GB, 16 GB
iPod nano 5th generation (video camera)	8 GB, 16 GB
iPod touch 2nd generation	8 GB, 16 GB, 32 GB, 64 GB
iPod classic	120 GB, 160 GB (2009)
iPod nano 4th generation (video)	8 GB, 16 GB
iPod classic	160 GB (2007)
iPod touch 1st generation	8 GB, 16 GB, 32 GB
iPod nano 3rd generation (video)	4 GB, 8 GB
iPod classic	80 GB
iPod nano 2nd generation (aluminum)	2 GB, 4 GB, 8 GB
iPod 5th generation (video)	60 GB, 80 GB
iPod 5th generation (video)	30 GB
iPod nano 1st generation	1 GB, 2 GB, 4 GB
iPod 4th generation (colour display)	40 GB, 60 GB
iPod 4th generation (colour display)	20 GB, 30 GB
iPod 4th generation	40 GB
iPod 4th generation	20 GB
iPod mini	4 GB, 6 GB

iPod/iPhone Playback

Preparation

- Make sure that the “IPOD” source is selected. Press [iPod] to select the source.
- **To view photos/videos from the iPod/iPhone**
Operate the iPod/iPhone menu to make the appropriate photo/video output settings for your TV.
- To display the picture, turn on the TV and select the appropriate video input mode.

Enjoy music/video

To use the iPod touch/iPhone features

- ① Press the Home button on the iPod touch/iPhone.
- ② Select the iPod touch/iPhone features on the touch screen to operate.

- 1 Press [iPod] to select “IPOD”.**
- 2 Press [STATUS] several times to select the music menu or videos menu.**
- 3 Press [▲, ▼] to select an item and press [OK].**
 - Repeat this step until the selected title starts playback.
 - Press [◀, ▶] to display the previous or next page.

e.g., music playback screen

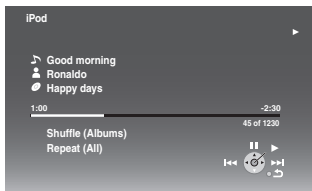

To exit, press [TOP MENU/DIRECT NAVIGATOR].

Enjoy photos

- 1 Press [iPod] to select “IPOD”.**
- 2 Press [STATUS] several times to select “ALL” on the unit’s display.**
- 3 Switch the TV input to video in.**
- 4 Play a slideshow on your iPod/iPhone.**
The picture will be displayed on your TV.

You can use the remote control to operate the iPod/iPhone menu.

The operation may vary among iPod/iPhone models.

- [▲, ▼]: To navigate menu items
- [OK]: To go to the next menu.
- [RETURN]: To return to the previous menu.

Other methods of playback

- 1 Press [START].**
- 2 Press [▲, ▼] to select “Menu” and then press [OK].**
- 3 Press [▲, ▼] to select “Play Mode” and then press [OK].**
- 4 Press [▲, ▼] to select an item and press [OK].**

Shuffle (For music playback only.)

Songs:

Play all songs on iPod/iPhone in random order.

Albums:

Play all songs on an album in random order.

Repeat

One:

Play a single song/video repeatedly.

All:

Play all songs/videos from selected items (e.g., Playlists, Albums, etc.) repeatedly.

- 5 Press [▲, ▼] to select the setting and press [OK].**



- The setting of the playback mode will be kept until changes are made on the same iPod/iPhone.
- This function does not work when “Use iPod display (All)” is selected.

Basic controls

(For music and video playback only)

Buttons	Functions
[▶ PLAY]	Play
[■ STOP]	Pause
[PAUSE]	
[SKIP ◀◀, SKIP ▶▶]	Skip
(Press and hold) [SEARCH ◀◀, SEARCH ▶▶]	Search



- Surround sound effect and sound mode are available (⇒ 24).

Enjoying VIERA CAST

You can access a selection of Internet services from the Home screen with VIERA CAST, for example YouTube, Picasa Web Albums. (Current as of December 2009)

Preparation

- Network connection (⇒ 18)
- Network setting (⇒ 20)

1 Press [VIERA CAST].

Message is displayed. Please read these instructions carefully and then press [OK].

2 Press [▲, ▼, ◀, ▶] to select the item and press [OK].

Operable buttons:
[▲, ▼, ◀, ▶], [OK], [RETURN], coloured buttons, numbered buttons

VIERA CAST Home screen;

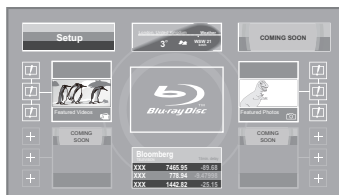

Images are for illustration purposes, contents may change without notice.

To return to VIERA CAST Home screen

Press [VIERA CAST].

To exit from VIERA CAST

Press [EXIT], [START] or [TOP MENU/DIRECT NAVIGATOR].

- When the Blu-ray disc logo is selected on the Home screen, the playback source will be changed and go back to the source previously selected.



- In the following cases, settings are possible using "Internet Content Settings" (⇒ 40)
 - When restricting the use of VIERA CAST.
 - When the audio is distorted.
 - When wrong time is displayed
- If using slow Internet connection, the video may not be displayed correctly. A high-speed Internet service with a speed of at least 6 Mbps is recommended.
- Be sure to update the firmware when a firmware update notice is displayed on the screen. If the firmware is not updated, you will not be able to use the VIERA CAST function. (⇒ 21)
- VIERA CAST home screen is subject to change without notice.
- The services through VIERA CAST are operated by their respective service providers, and service may be discontinued either temporarily or permanently without notice. Therefore, Panasonic will make no warranty for the content or the continuity of the services.
- All features of websites or content of the service may not be available.
- Some content may be inappropriate for some viewers.
- Some content may only be available for specific countries and may be presented in specific languages.

Playback menu

1 Press [BD/SD] to select "BD/DVD".

2 Press [DISPLAY].

e.g., BD-Video

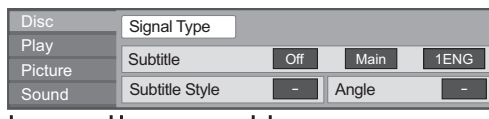

Menus Items Settings

3 Press [▲, ▼] to select the menu and press [▶].

4 Press [▲, ▼, ◀, ▶] to select the item and press [▶].

5 Press [▲, ▼] to select the setting.

Some items can be changed by pressing [OK].

To exit the screen

Press [DISPLAY].

Depending on the condition of the unit (playing, stopped, etc.) and media contents, there may be some items that you cannot select or change.

Regarding Language, Audio attribute and Video attribute: (⇒ 47)

Disc

Signal Type

Primary Video

Video	The recording method of original video appears.
Soundtrack	Select the type of audio or language.

Secondary Video

Video	Select on/off of images. The recording method of original video appears.
Soundtrack	Select on/off of audio and the language.

Video

The recording method of original video appears.

Soundtrack

Show or change the soundtrack.

Subtitle

Turn the subtitle on/off, and change the language depending on the media.

Subtitle Style

Select the subtitle style.

Audio channel

Select the audio channel number.
(⇒ 25, "Changing audio")

Angle

Select the number of the angle.

Some items may be changed only on the disc specific menu. (⇒ 25)

Play

Repeat Play

(Only when the elapsed time is being displayed on the unit's display.)

Select the item which you want to repeat. The items displayed differ depending on the type of media.



Select "Off" to cancel.

Random

Select whether or not to play random.

Playback Information Window

Displays the following.

	Audio/video attribute information of disc.
	Settings status of "Digital Audio Output" (⇒ 38).
	HDMI output information.

Press [RETURN] to exit.

Picture

Mode

Select the picture quality mode during play.

Detail Clarity

The picture is sharp and detailed.

Progressive

Select the method of conversion for progressive output to suit the type of material being played.

- If the video is disrupted when "Auto" is selected, select either "Video" or "Film" depending on the material to be played back.

24p

Movies and other material recorded on DVD-Video at 24p are output at 24p.

- Only when you have selected "On" in "24p Output" (⇒ 39) and play discs recorded at a rate of 60 fields per second.

Sound

Sound Effects*1, *2

(Discs recorded at 48 kHz or less)

This feature gives you brighter sound by increasing the high frequency portion of the audio.

Re-master 1	Pop and rock
Re-master 2	Jazz
Re-master 3	Classical

Dialog Enhancer*1

The volume of the centre channel is raised to make dialog easier to hear.

High Clarity Sound

When connected to TV via HDMI AV OUT terminal for outputting image, it produces clearer sound.

Only when you have selected "Enable" in "High Clarity Sound" (⇒ 38)

*1 When audio is output from the HDMI AV OUT terminal this function is effective only when "Dolby D/Dolby D +/Dolby TrueHD" or "DTS/DTS-HD" is set to "PCM". (⇒ 38)

*2 This function has no effect when the type of audio is Dolby Pro Logic II.

DLNA feature

You can enjoy music, video and picture contents saved on a DLNA Certified media server (such as a PC with Windows 7 installed etc.) connected to the home network with this unit. You also can enjoy viewing them with Panasonic DLNA compatible recorders (DIGA).

- The countries where DIGA is available are limited. Refer to following site for availability.
<http://panasonic.jp/support/global/cs/>
- For the operation of equipment connected to the network, refer their respective operating instructions.

Preparation

- ① Perform network connection (⇒ 18) and network setting (⇒ 20).
- ② Connect a DLNA Certified media server to the network.

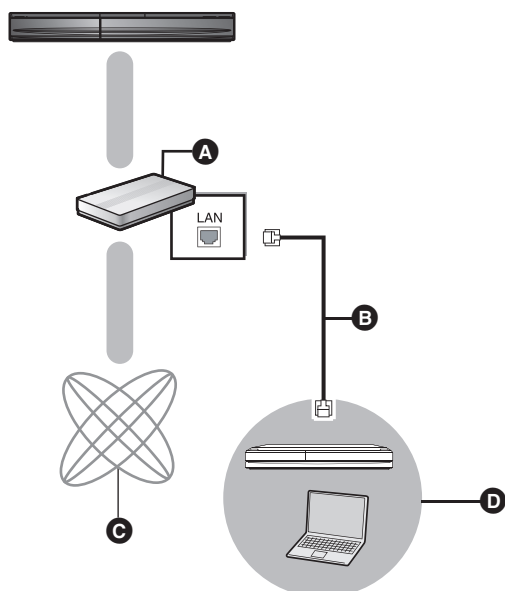

- A** Broadband router, Wireless router (Access point), etc.
- B** LAN Cable (Straight)
- C** Internet
- D** DLNA Certified media server

When connected to a Panasonic DLNA compatible recorder (DIGA)

Perform the Home Network (DLNA) setup.

When a message requesting operation of the equipment to be registered is displayed, perform the operations in steps 1-4 of "Enjoy contents on the equipment connected to this unit via the network" (⇒ right).

Enjoy contents on the equipment connected to this unit via the network

- 1 Press [START].
- 2 Press [▲, ▼] to select "Network" and press [OK].
- 3 Press [▲, ▼] to select "Home Network (DLNA)" and press [OK].
 - A list of equipment connected via the network is displayed.
 - This list can be updated by pressing the red button on the remote control.

e.g.

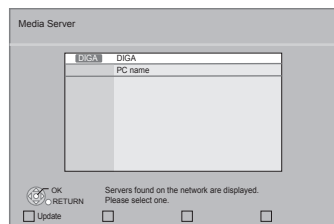

- 4 Press [▲, ▼] to select the equipment to playback the contents, and press [OK].
- 5 Press [▲, ▼, ◀, ▶] to select the item to playback (folder), and press [OK].
 - Menu structure will be different depending on the equipment connected to this unit. Select the contents by repeating the operation.
 - Control Panel is displayed once the playback starts. Operation can be performed with [▲, ▼, ◀, ▶], [OK], [RETURN] and [EXIT].

Control Panel

e.g.

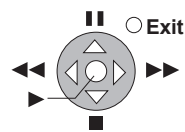

- Press [OK] if the Control Panel is not displayed.



- Discs cannot be played back. Also, depending on the equipment, playback of pictures may not be possible.
- Items displayed in grey on the display cannot be played back by this unit.
- This unit cannot be played back via connected equipment.
- Depending on the performance of the connected PC, video frames may be dropped during playback, or it may not playback at all.

Useful functions for when playing back pictures

The following operations are possible when playing back pictures from connected equipment.

While picture list screen or folder with picture list screen is displayed

- ① Press [OPTION].
- ② Select an item, then press [OK].

Start Slideshow	You can display still pictures one by one at a constant interval.
Slideshow Settings	<p>Display Interval Change the display interval.</p> <p>Repeat Play Repeat slideshow.</p> <p>Press [▲, ▼, ◀, ▶] to select “Set” and press [OK].</p>

While playing

- ① Press [OPTION].
- ② Select an item, then press [OK].

Status	Show the picture properties (⇒ 28).
Rotate RIGHT (except for slideshow)	Rotate the still picture.
Rotate LEFT (except for slideshow)	

Setup menu

Change the unit's settings if necessary. The settings remain intact even if you switch the unit to standby.

- 1 Press [START] and press [▲, ▼] to select “To Others” and press [OK].
- 2 Press [▲, ▼] to select “Setup” and press [OK].

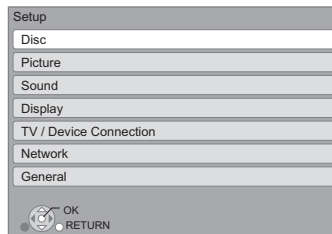

- 3 Press [▲, ▼] to select the menu and press [OK].
- 4 Press [▲, ▼] to select the item and press [OK].
If there are any other items, repeat these steps.
- 5 Press [▲, ▼, ◀, ▶] to select the option and press [OK].

- There may be differences in operation methods. If this happens, follow the on-screen instructions for the operation.

About the password

The password of the following items are common. Don't forget your password.

- “DVD-Video Ratings”
- “BD-Video Ratings”
- “Lock” (⇒ 40)

Disc

DVD-Video Ratings

Set a ratings level to limit DVD-Video play.

- Follow the on-screen instructions. Enter a 4-digit password with the numbered buttons when the password screen is shown.

BD-Video Ratings

Set an age limit of BD-Video play.

- Follow the on-screen instructions. Enter a 4-digit password with the numbered buttons when the password screen is shown.

Soundtrack Preference

Choose the language for audio.

- If “Original” is selected, the original language of each disc will be selected.
- Enter a code (⇒ 47) with the numbered buttons when you select “Other ****”.

Subtitle Preference

Choose the language for subtitle.

- If "Automatic" is selected and the language selected for "Soundtrack Preference" is not available, subtitles of that language will automatically appear if available on that disc.
- Enter a code (⇒ 47) with the numbered buttons when you select "Other ****".

Menu Preference

Choose the language for disc menus.

- Enter a code (⇒ 47) with the numbered buttons when you select "Other ****".

BD-Live Internet Access (⇒ 26)

You can restrict Internet access when BD-Live functions are used.

- If "Limit" is selected, Internet access is permitted only for BD-Live contents which have content owner certificates.

DivX Subtitle Text

Select a suitable item according to the language used for DivX subtitles text (⇒ 27).

- This item is displayed only after playing back a file.

Picture

Still Mode

Select the type of picture shown when you pause playback.

Automatic	Automatically selects the type of picture shown.
Field	Select if jittering occurs when "Automatic" is selected.
Frame	Select if small text or fine patterns cannot be seen clearly when "Automatic" is selected.

Seamless Play

The chapters segment in playlists are played seamlessly.

- Select "On" when the picture freezes for a moment at the chapters segment in playlists.

NTSC Contents Output

Select PAL60 or NTSC output when playing NTSC discs.

Sound

Dynamic Range Compression

You can listen at low volumes but still hear dialogue clearly. (Dolby Digital, Dolby Digital Plus and Dolby TrueHD only)

- "Auto" is effective only when playing Dolby TrueHD.

Digital Audio Output

Press [OK] to show the following settings.

Dolby D/Dolby D +/Dolby TrueHD DTS/DTS-HD MPEG Audio

Select the audio signal to output.

- Select "PCM" when the connected equipment cannot decode the respective audio format.
- Not making the proper settings may result in noise.

BD-Video Secondary Audio

Select whether to mix or not mix the primary audio and secondary audio (including the button click sound). (⇒ 26)

- If "Off" is selected, the unit outputs the primary audio only.

Digital Audio Input

Select whether to receive the digital sound as PCM or the original sound format.

Select "On" if the sound is cut off intermittently.

Downmix

Select the downmix system to enjoy multi-channel or 2-channel sound.

- Select "Surround encoded" to enjoy the surround sound.
- There is no downmix effect on the bitstream audio signal.
- The audio will be output in "Stereo" in the following cases.
 - AVCHD playback
 - Playback of secondary audio (including the button click sound).

7.1ch Audio Reformating

Surround sound with 6.1ch or less is automatically expanded and played back at 7.1ch.

- If "Off" is selected, sound is played over the original number of channels. (Note that in the case of 6.1ch audio, playback will be at 5.1ch.)
- Audio reformatting is enabled in the following cases:
- When you have selected "PCM" in "Digital Audio Output".
 - When the audio is Dolby Digital, Dolby Digital Plus, Dolby TrueHD or LPCM.

High Clarity Sound

When connected to TV via HDMI AV OUT terminal for outputting image, it produces clearer sound.

- Set to "Enable" and then set "High Clarity Sound" on the playback menu to "On". (⇒ 35)

Audio Delay

Mis-sync between the video and audio is corrected by delaying the audio output.

Speaker

Refer to page 41

Display

On-Screen Messages

Choose whether to show status messages automatically.

On-Screen Language

Choose the language for these menus and on-screen messages.

Screen Saver Function

This is to prevent burn-in on the screen.

- When this is set to "On":
 - If there is no operation for 5 minutes or more, DIRECT NAVIGATOR screen switches to START menu automatically.
 - While playing and pausing, etc., this function is not available.
- As for Music [CD-DA] or MP3, regardless of the setting, if there is no operation for a while, DIRECT NAVIGATOR screen switches to the other states automatically.

FL Display

Changes the brightness of the unit's display.

- If "Automatic" is selected, the display is dimmed but brightens when you perform some operations.
-

Software Licence



Information about the software used by this unit is displayed.

TV / Device Connection

TV Aspect

Set to match the type of television connected.

When connected to a 4:3 aspect television and playing 16:9 ratio image:

4:3	The sides are cut off so the picture fills the screen. When playing BD-Video, video is output as "4:3 Letterbox".	
4:3 Letterbox	Black bands appear at the top and bottom of the picture.	

When connected to a 16:9 widescreen television and playing 4:3 ratio image:

16:9	Video is displayed as a 4:3 ratio image in the centre of the screen.
-------------	--

HDMI Connection

Press [OK] to show the following settings.

HDMI Video Format

The items supported by the connected devices are indicated on the screen as "*". When any item without "*" is selected, the images may be distorted.

- If "Automatic" is selected, automatically selects the output resolution best suited to the connected television.
 - To enjoy high definition video up-converted to 1080p, you need to connect the unit directly to 1080p compatible HDTV (High Definition Television). If this unit is connected to an HDTV through other equipment, it must also be 1080p compatible.
-

24p Output

When this unit is connected to a TV supporting 1080/24p output using an HDMI cable, movies and other material recorded at 24p are output at 24p.

- When playing DVD-Video, set to "On" and then set "24p" in "Picture" (⇒ 35) to "On"
 - When BD-Video images other than 24p are played, images are output at 60p.
-

HDMI Colour Mode

This setting is for selecting colour-space conversion of the image signal when the unit is connected using an HDMI cable.

HDMI Audio Output

This setting selects whether or not to output audio from HDMI.

- Audio will be output through the system's speakers when "Off" is selected.
-

VIERA Link

Set to use "HDAVI Control" function when connected with an HDMI cable to a device that supports "HDAVI Control".

- Select "Off" when you do not want to use "HDAVI Control".
-

Deep Colour Output

This setting is for selecting whether to use Deep Colour Output when a television that supports Deep Colour is connected.

Contents Type Flag

Depending on the playback content, the TV will output adjusting to the optimal method when a TV that supports Contents Type Flag is connected.

Power Off Link

Select the desired power off link setting of this unit for VIERA Link operation (⇒ 32). (This works depending on the settings of the connected VIERA Link "HDAVI Control" compatible equipment.)

Video/Audio:

When the TV is turned off, this unit will turn off automatically.

Video:

When the TV is turned off, this unit will turn off except during the following conditions:

- CD or MP3 audio playback
 - iPod/iPhone mode
 - Radio mode
 - "AUX", "ARC" or "D-IN 1" (DIGITAL IN 1) mode (non-selected TV AUDIO setting for VIERA Link)
 - "D-IN 2" (DIGITAL IN 2) mode (non-selected CABLE/SAT AUDIO setting for VIERA Link)
-

TV Audio Input

Select the TV audio input to work with the VIERA Link operations

TV System

Change the setting to match the equipment you are connecting with.

- When NTSC contents are played, they are outputted in the signal format specified in the "NTSC Contents Output", irrespective of the settings here.
-

Network Easy Setting (⇒ 20)

Network Settings

Perform network-related settings individually.
Press [OK] to show the following settings.

LAN Connection Mode

Select connection method.

Access Point Connection Setting

This allows the Wireless router (Access point) and connection settings to be set and the current connection settings and connection state to be checked when a wireless connection is used.

Connection Setting

The Wireless router (Access point) connection wizard will be displayed.

IP Address / DNS Settings

This is for checking the state of the network connection and setting the IP address and DNS-related.
Press [OK] to show the respective setting.

- “Connection Speed Setting” is enabled only when “Connection Speed Auto-Config” is turned “Off”.

Proxy Server Settings

This is for checking the state of connection with the Proxy server and performing settings.
Press [OK] to show the respective setting.

Internet Content Settings (⇒ 34) (VIERA CAST)

Press [OK] to show the following settings.

Lock

You can restrict using VIERA CAST.

- Follow the on-screen instructions. Enter a 4-digit password with the numbered buttons when the password screen is shown.

Audio Auto Gain Control

Volume that is different depending on the contents is adjusted automatically to the standard volume while using the VIERA CAST.

- Depending on contents, this function effect will not work.
- Select “Off” when the audio is warped.

Time Zone

By selecting the time zone, it is possible to set the unit's time to match your location.

- Some VIERA CAST contents require the time zone to be set. Set the time zone if necessary.

Summer Time

- Select “On” when using Daylight Saving time.

MAC Address

Displays the MAC address of this unit.

Remote Control

Change the remote control code if other Panasonic products react to this remote control.

Quick Start*

Speed of startup from standby mode is increased.

- Internal control unit will be powered when it is set to “On” so compared to when the setting is “Off” the following will occur.
 - Idle power consumption will increase. (about the power consumption ⇒ 50)

*The cooling fan may turn slowly to prevent overheating of internal parts.

* Depending on the power conserving setting activated on the TV, this function may have less effect when the unit is started by the power on link function. (⇒ 31)

BT735 BT330 Smart setup / BT230 Easy setup (⇒ 19)

You can execute basic settings to optimize your home theatre system.

Default Settings

This returns all values in the Setup menu and the playback menu, except for “Remote Control”, “On-Screen Language”, “IP Address / DNS Settings”, “Proxy Server Settings”, “Lock”, “DVD-Video Ratings” and “BD-Video Ratings” to the default settings.

DivX Registration (⇒ 27)

You need this registration code to purchase and play DivX Video-on-Demand (VOD) content.

System Information

Display firmware version of this unit and wireless LAN module of optional Wireless LAN Adaptor.

Firmware Update (⇒ 21)

Press [OK] to show the following settings.

Automatic Update Check

When this equipment remains connected to the Internet, it will check for the latest firmware version when it is turned on and you can update it if necessary.

Update Now

You can update the firmware manually.

Speaker settings

Delay time (ms)

For optimum listening with 5.1-channel sound, all the speakers, except for the subwoofer, should be the same distance from the seating position. If either distance (A) or (B) is less than (C) (⇒ below), find the difference in the relevant table and adjust the delay time to make up for the difference.

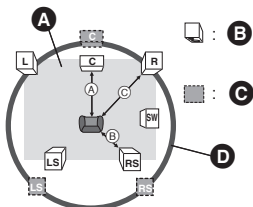

- (A) (B) (C): Primary listening distance
- (A) Approximate room dimensions
- (B) Actual speaker position
- (C) Ideal speaker position
- (D) Circle of constant primary listening distance

1 Press [▲, ▼, ◀, ▶] to select the distance box (ms) and press [OK].

e.g., 5.1ch setting

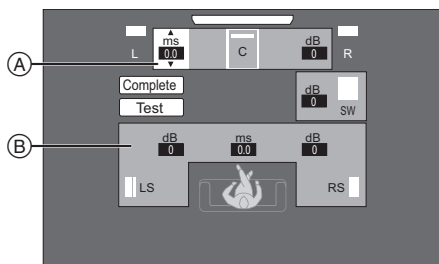

- (A) Centre (C)
 - (B) Left Surround (LS), Right Surround (RS)
- e.g., 7.1ch setting

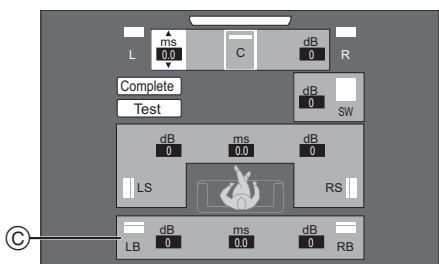

- (C) Left Surround back (LB), Right Surround back (RB)

2 Press [▲, ▼] to select the setting and press [OK].

- (A) Centre speaker

Difference	Setting
Approx. 34 cm	1.0 ms
Approx. 68 cm	2.0 ms
Approx. 102 cm	3.0 ms
Approx. 136 cm	4.0 ms
Approx. 170 cm	5.0 ms

- (B) Surround / Surround back speakers

Difference	Setting
Approx. 170 cm	5.0 ms
Approx. 340 cm	10.0 ms
Approx. 510 cm	15.0 ms

■ When using the 7.1ch speaker system

- ① Check the distance difference of both the front speakers and the surround back speakers from the seating position.
- ② Set the delay time of the surround back speakers.

Adjusting speaker level

Volume (Channel balance) (dB)

(Effective when playing multi-channel audio)

1 Select "Test" and press [OK].

A test signal is output.

2 While listening to the test signal

Press [▲, ▼] to adjust the volume of each speaker.

The volume can be adjusted between +6 dB to -6 dB.

- Set each speaker level according to the volume of the Front (L) and Front (R) speaker volume respectively.
- No signal is output for the subwoofer. To adjust its volume, see page 24, "Adjusting speaker level during play".

3 Press [OK].

The test signal stops.

e.g., 5.1ch setting

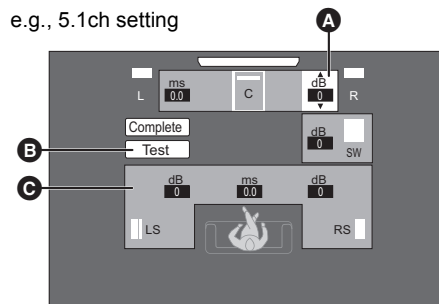

- (A) Centre (C)
- (B) Test
- (C) Left Surround (LS), Right Surround (RS)

To finish the speaker setting

Press [▲, ▼, ◀, ▶] to select "Complete" and press [OK].

Speaker installation option

Attaching to a wall

- You can attach all of the speakers (except subwoofer) to a wall.
- The wall or pillar on which the speakers are to be attached should be capable of supporting 10 kg per screw. Consult a qualified building contractor when attaching the speakers to a wall. Improper attachment may result in damage to the wall and speakers.
 - Do not attempt to attach these speakers to walls using methods other than those described in this manual.

1 Drive a screw (not included) into the wall.

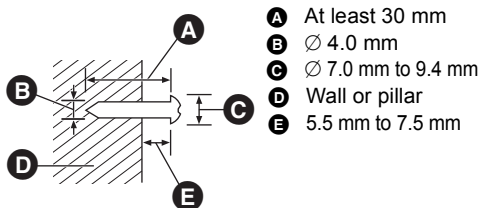

2 Fit the speaker securely onto the screw(s) with the hole(s).

e.g., BT735 Front speaker	
DO NOT	DO
<ul style="list-style-type: none"> • In this position, the speaker will likely fall if moved to the left or right. 	<ul style="list-style-type: none"> • Move the speaker so that the screw is in this position.

BT735: Front speaker, Surround speaker

BT330: Front speaker

Attach to a wall without the base and the stand.

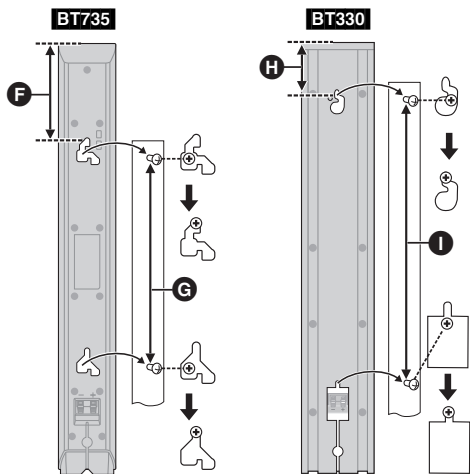

BT330: Surround speaker

BT230: Front speaker, Surround speaker

- F** 97 mm
G 210 mm to 212 mm
H 72 mm
I 349 mm to 351 mm
J 26 mm

BT735: Centre speaker

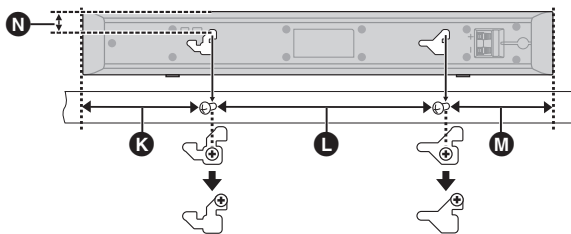

BT330 **BT230**: Centre speaker

- K** 117 mm
L 209 mm to 211 mm
M 97 mm
N 18.8 mm
O 17 mm
P 99 mm to 101 mm

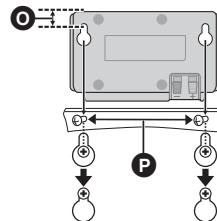

To avoid speaker dropping

BT735: Front speaker, Centre speaker, Surround speaker

BT330: Front speaker

e.g., **BT735**: Front speaker

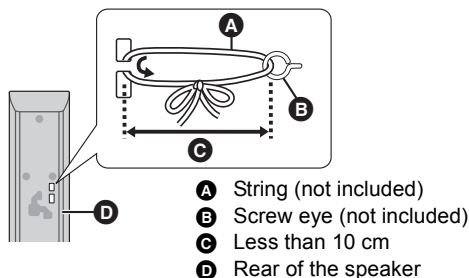

- Consult a qualified building contractor to avoid damage to the wall or speakers.
- Use a string of less than \varnothing 2.0 mm, which is capable of supporting over 10 kg.

Reattaching the speaker cable

BT330

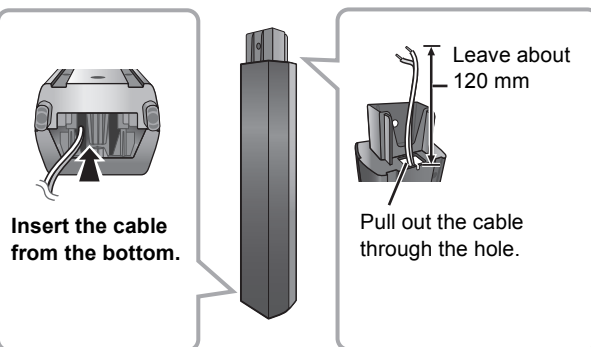

Troubleshooting guide

Before requesting service, please perform the following steps.

Do you have the latest firmware installed?

Firmware updates may be released to correct operating irregularities that are discovered with certain movies. (⇒ 21)

Make the following checks.

If the problem remains unresolved, consult your dealer for instructions.

The following do not indicate a problem with this unit:

- Regular disc rotating sounds.
- Image disturbance during search.

Unit doesn't respond to remote control or front panel buttons.

Press and hold [⏻/I] on the main unit for 5 seconds.

— If still unable to turn the unit off, disconnect the AC mains lead, wait 1 minute, then reconnect the AC mains lead.

Cannot eject disc.

The unit may have a problem.

While the unit is off, press and hold [SKIP▶▶] on the remote control and [▲ OPEN/CLOSE] on the unit at the same time for more than 5 seconds.

General operation

To return to the factory preset.

- Select "Yes" in "Default Settings" in the Setup menu. (⇒ 40)

To return all settings to the factory preset.

- Reset the unit as follows:
While the unit is off, press and hold [+ VOLUME], [▲ OPEN/CLOSE] and [⏻/I] on the main unit at the same time for more than 5 seconds.

The remote control doesn't work properly.

- The remote control and main unit are using different codes. Change the code on the remote control. (⇒ 22)
- It may be necessary to set the code of the remote control again after changing the batteries for remote control. (⇒ 22)

Disc cannot be played.

- The disc is dirty. (⇒ 7)
- Check the region code.

Still pictures (JPEG) do not playback normally.

- The images that were edited on the PC, such as Progressive JPEG, etc., may not playback.

The TV tuner mode is not displayed when the TV is switched on.

- This phenomenon may occur, depending on the TV setting, when "Quick Start" is set to "On".
- Depending on the TV, this phenomenon may be prevented by reconnecting the HDMI cable to a different HDMI input terminal or by changing the HDMI auto connection setting.

The contents of the USB device cannot be read.

- If inserted during playback, the USB device may not be recognised by this unit.

You have forgotten your ratings password.

You want to cancel the ratings level.

While the disc tray is empty and "BD/DVD" is selected as a source, press and hold [SKIP◀◀] on the remote control and [▶] (Play) on the unit at the same time for more than 5 seconds. The ratings level returns to the factory preset.

Power

No power.

- Insert the AC mains lead securely into a household mains socket. (⇒ 18)

The unit switches to standby mode.

- When the time set for the sleep timer has passed, the power will be turned off. (⇒ 8)
- One of the unit's safety devices is activated. Press [⏻/I] on the main unit to turn the unit on.

The main unit is turned off when the input for the TV is changed.

- This is a normal phenomenon when using VIERA Link (HDAVI Control 4 or later). For details please read the operating instructions for the TV.

Displays

The display is dim.

- Change "FL Display" in the Setup menu. (⇒ 39)

TV screen and video

The images from this unit do not appear on the TV.

Picture is distorted.

Jittering occurs.

- An incorrect resolution is selected in "HDMI Video Format". Reset the setting as follows:
While the disc tray is empty and "BD/DVD" is selected as a source, press and hold [▶] (Play) and [■] (Stop) on the main unit at the same time for more than 5 seconds to cancel the setting.
- When Dolby Digital Plus, Dolby TrueHD, and DTS-HD audio are not output in bitstream, select "Yes" in "Default Settings" and make proper settings. (⇒ 40)
- The unit and television are using different video systems. While stopped, keep pressing [■] (Stop) and [▲ OPEN/CLOSE] on the main unit for 5 or more seconds. The system switches from PAL to NTSC or vice versa.
- The system used on the disc doesn't match your television.
 - PAL discs cannot be correctly viewed on an NTSC television.
 - This unit can convert NTSC signals to PAL60 for viewing on a PAL television ("NTSC Contents Output" in the "Picture").

Video is not output.

- Set the "High Clarity Sound" in the playback menu to "Off" to use the VIDEO OUT terminal. (⇒ 35)

Video is not output in high definition.

- Confirm that "HDMI Video Format" in the Setup menu is set properly. (⇒ 39)

A black band is displayed around the edge of the screen.

The aspect ratio of the screen is abnormal.

- Confirm the "TV Aspect" is set properly. (⇒ 39)
- Adjust the aspect setting on the television.
(Adjustment using "Screen Aspect" (⇒ 26) on the unit is also possible.)

After choosing "Home Cinema" in "Speaker Selection" with the TV's remote control, the TV's input selection also changes.

- Disconnect the HDMI cable from the TV and reconnect it to a different HDMI IN terminal.

Sound

No sound.

Low volume.

Distorted sound.

Cannot hear the desired audio type.

- Check connections to speakers and other equipment. (⇒ 12, 13, 15–18)
- Ensure the speaker settings for your speakers are correct. (⇒ 41)
- To output audio from a device connected with an HDMI cable, set “HDMI Audio Output” to “On” in the Setup menu. (⇒ 39)
- When “BD-Video Secondary Audio” is set to “On”, Dolby TrueHD, Dolby Digital Plus, DTS-HD Master Audio and DTS-HD High Resolution Audio are output as Dolby Digital or DTS Digital Surround.
- Re-master will not work when the bitstream signal is output from the HDMI AV OUT terminal. (⇒ 35)
- Depending on the connected equipment, the sound may be distorted if this unit is connected with an HDMI cable.
- The multi-channel audio from a device connected to the TV is not output in its original multi-channel form.
 - If the device has an optical audio output terminal, connect the device to this unit’s “OPTICAL 2” terminal. (⇒ 17, 30)

No surround sound.

- Press [SURROUND] to select a surround effect. (⇒ 24)
- (When using the 7.1ch speaker system)
Audio is not available from the surround back speakers even though Dolby Pro Logic II turns on.

Cannot switch audio.

- When audio is output from the HDMI AV OUT terminal, set “Dolby D/Dolby D +/Dolby TrueHD”, “DTS/DTS-HD” or “MPEG Audio” to “PCM”. (⇒ 38)

No sound from the TV.

- Press [EXT-IN] to select the corresponding source. (⇒ 23)
- The ARC (Audio Return Channel) function is not available. Instead, use an optical digital audio cable or an audio cable to have the TV sound. (⇒ 16, 17)
- If the TV is not ARC compatible and only the HDMI connection is used, an extra audio connection is necessary (⇒ 16, 17).

iPod/iPhone operation

Cannot charge or operate.

- Check that the iPod/iPhone is connected firmly. (⇒ 32)
- The battery of the iPod/iPhone is depleted. Charge the iPod/iPhone, and then operate again.

Cannot display iPod/iPhone videos/photos on the TV.

- Make sure that TV is connected to the VIDEO OUT terminal on this unit. (⇒ 16)
- Operate the iPod/iPhone menu to make the appropriate video/photo output settings for your TV. (Refer to operating instructions for your iPod/iPhone.)

The TV input channel unintentionally changes to HDMI input.

- When the main unit is connected with an “HDAVI Control” compatible TV and VIDEO IN is selected for iPod/iPhone video or photo playback, the TV input channel will automatically change to the HDMI input channel when [START] is pressed.
 - Re-select the TV’s VIDEO IN input channel.

Radio

Distorted sound or noise is heard.

- Adjust the position of the antenna.
- Use an outdoor antenna. (⇒ 15)

A beat sound is heard.

- Try to keep a certain amount of distance between the antenna and the TV.

Network

I can’t connect to the network.

- Confirm the network connection and settings. (⇒ 18, 40)
- Check the operating instructions for each device and connect accordingly.

When using Wireless LAN connection, video or audio from the DLNA Certified media server is played back intermittently, not played back or video frames are dropped during playback.

- Higher transfer rate router such as 802.11n (2.4 GHz or 5 GHz) Wireless router (Access Point) may solve the problem. If you use 802.11n (2.4 GHz or 5 GHz) Wireless router (Access Point), it is necessary to set the encryption type to “AES”. Simultaneous use with a microwave, cordless telephone etc. at 2.4 GHz may result in connection interruptions or other problems.
- On the “Access Point Connection Setting” screen (⇒ 40), the continuous lighting of at least 4 “Reception” indicators is the target for a stable connection. If 3 or fewer indicators are lit or the connection is being interrupted, change the position or angle of your Wireless router (Access point) and see if the connection state improves. If there is no improvement, connect to a wired network and perform the “Network Easy Setting” (⇒ 20) again.

The contents of the USB device cannot be read.

- USB devices connected using USB extension cable other than the included with the Wireless LAN Adaptor DY-WL10 (optional) or a USB hub may not be recognised by this unit.

Other difficulties with playback

BD-Video or DVD-Video is not played.

- Ensure the disc is for the correct BD-Video region code or DVD-Video region number, and is not defective. (⇒ 11)
- You have set a ratings level to limit BD-Video or DVD-Video play. Change this setting. (⇒ 37)
- Some BD-Video can only be output with HDMI.

I can’t play back BD-Live.

- The SD card is write-protected. (⇒ 11)
- Confirm that this unit is connected to the broadband Internet. (⇒ 18)
- Confirm the “BD-Live Internet Access” settings. (⇒ 38)
- Confirm an SD Card is inserted into the SD Card slot. (⇒ 22)

Alternative soundtrack and subtitles cannot be selected.

- The languages are not recorded on the disc.
- You may not be able to use the playback menu to change the soundtrack and subtitles on some discs. Use the disc’s menus to make changes. (⇒ 25)

Angle cannot be changed.

- Angles can only be changed during scenes where different angles are recorded.

Messages

The following messages or service numbers appear on the television or unit's display when something unusual is detected during startup and use.

On the television

Cannot play.

- You inserted an incompatible disc.

Cannot play on this unit.

- You tried to play a non-compatible image.

No disc is inserted.

- The disc may be upside down.

⊗ This operation is not available.

- Some operations are unsupported by the unit. For example;
 - BD-Video: During playback, reverse slow-motion or reverse frame-by-frame is not possible.

IP address is not set.

- The "IP Address" in "IP Address / DNS Settings" is "----. ---. ---. ---". Set the "IP Address", "Subnet Mask", and "Gateway Address". (Select the automatic address acquisition if necessary.)

(When using the optional wireless LAN adaptor: DY-WL10)

The current security setting of Wireless LAN is low. It is recommended to change the setting.

- Authentication type for the Wireless LAN is set to "Open system", or the encryption type is set to "No encryption". It is recommended to encrypt for safety reasons. For details, refer to the instructions of the Wireless router being used. Encryption is required when playing back video, etc., from DLNA compatible devices.

No Video

- Depending on the connected iPod/iPhone, video menu may not be available on the TV. Select "ALL" on the unit's display and operate video playback from your iPod/iPhone menu. (⇒ 33)

On the unit's display

F99

- The unit fails to operate properly. Press [⏻] on the main unit to switch the unit to standby for 3 seconds. Now press [⏻] on the main unit again to turn the unit on.

U59

- The unit is hot.
The unit switches to standby for safety reasons. Wait for about 30 minutes until the message disappears. Select a position with good ventilation when installing the unit. Do not block the ventilation hole on the rear and side of the unit.

U72

U73

- The HDMI connection acts unusually.
 - Turn the unit and TV off.
 - Disconnect the HDMI cable between the player and the TV.

HDMI ONLY

- Some BD-Video discs can only be output with HDMI.

NET

- Displays while VIERA CAST is starting up.

No PLAY

- There is a viewing restriction on a BD-Video or DVD-Video. (⇒ 37)

No READ

- The media is dirty or badly scratched. The unit cannot play.

PLEASE WAIT

- The unit is carrying out internal process. This is not a malfunction. You cannot operate the unit while "PLEASE WAIT" is displayed.

REMOVE

- The USB device is drawing too much power. Remove the USB device.

SET □

("□" stands for a number.)

- The remote control and main unit are using different codes. Change the code on the remote control. (⇒ 22)

H□□ or F□□

("□" stands for a number.)

- Check and correct the speaker cable connections.
- There is something unusual.
- Check the unit using the troubleshooting guide. If the service number does not disappear, do the following.
 - ① Disconnect the plug from the household mains socket, wait a few seconds, then reconnect it.
 - ② Press [⏻/|] to turn the unit on.
If the service number does not disappear despite doing the above, request service from the dealer. Inform the dealer of the service number when requesting service.

UPD□/□

("□" stands for a number.)

- The firmware is being updated.
Please do not turn off the unit.

IPOD OVER CURRENT ERROR

- The iPod/iPhone is drawing too much power. Remove the iPod/iPhone, and turn the unit off and on again.

START

- The system is being restarted during the firmware update.
Please do not turn the unit off.

FINISH

- The firmware update is completed.

NOT CONDITIONAL

- The requested operation cannot be conducted.

About MP3/JPEG/DivX/AVCHD/MPEG2 files

MP3

File format	MP3
Extension	Files must have the extension ".mp3" or ".MP3".
Compression rate	32 kbps to 320 kbps
Sampling rate	44.1 kHz/48 kHz
Reference	ID3 tags: version 1, 2.2, 2.3, 2.4 (Only titles and the names of artists)

JPEG

File format	JPEG
Extension	Files must have the extension ".jpg" or ".JPG".
Picture resolution	between 34×34 and 8192×8192 pixels (sub sampling is 4:2:2 or 4:2:0)
Reference	JPEG conforming DCF* is supported. <ul style="list-style-type: none"> • MOTION JPEG and Progressive JPEG is not supported.

* Design rule for Camera File system: unified standard established by Japan Electronics and Information Technology Industries Association (JEITA).

- DVD-RAM must conform to UDF 2.0.
- BD-RE must conform to UDF 2.5.

DivX

File format	DivX
Extension	Files must have the extension ".DIVX", ".divx", ".AVI" or ".avi".
Picture resolution	Up to 1920×1080 pixels
Reference	<ul style="list-style-type: none"> • DivX certified to play DivX video up to HD 1080p, including premium content. <ul style="list-style-type: none"> Video <ul style="list-style-type: none"> – Number of stream: Up to 1 – Codec: DIV3, DIV4, DIVX, DX50, DIV6 – FPS (Frame Per Second): Up to 60 fps Audio <ul style="list-style-type: none"> – Number of stream: Up to 8 – Format: MP3, MPEG, Dolby Digital – Multi channel: Dolby Digital is possible. MPEG multi is 2 ch conversion. • GMC (Global Motion Compensation) is not supported.

- DVD-R and DVD-R DL must conform to UDF 1.02 without ISO9660 and UDF 1.5 with ISO9660.
- BD-R must conform to UDF 2.5.

Subtitles text file of DivX

File format	Subtitles text file of DivX
File format	MicroDVD, SubRip, or TMLayer
Extension	Files must have the extension ".SRT", ".srt", ".SUB", ".sub", ".TXT", or ".txt"
Reference	<ul style="list-style-type: none"> • The DivX video file and subtitles text file are inside the same folder, and the file names are the same except for the file extensions. • Depending on the methods used to create the file or the state of the recording, only parts of the subtitles may be displayed, or the subtitles may not be displayed at all.

AVCHD

File format	AVCHD format (V1.0) used on High Definition Video Camera (Panasonic and some other's)
Codec	MPEG-4 AVC/H.264
	<ul style="list-style-type: none"> • Discs must conform to UDF 2.5.

MPEG2

File format	SD-Video format* used on Standard Definition Video Camera (Panasonic and some other's)
Codec	MPEG2
	* SD-Video Entertainment Video Profile



- With certain recording states and folder structures, the play order may differ or playback may not be possible.
- CD-R, CD-RW: ISO9660 level 1 or 2 (except for extended formats), Joliet
This unit is compatible with multi-session.
This unit is not compatible with packet writing.
- DVD-R, DVD-R DL (except for AVCHD): ISO9660 level 1 or 2 (except for extended formats), Joliet, UDF bridge (UDF 1.02/ISO9660)
This unit is not compatible with multi-session.
This unit is not compatible with packet writing.

Structure of folders that can be played in this unit

You can play files on this unit by structure of folders as shown below. However depending on the method of writing data (writing software), play may not be in the order you numbered the folders.

: Folder which can be displayed with this unit

::*: Numbers

XXX: Letters

*1 ***: from 001 to 999

*2 ***: from 100 to 999

XXXXX: 5 figures

*3 *****: from 0001 to 9999

XXXX: 4 figures

Structures of still picture (JPEG) folders

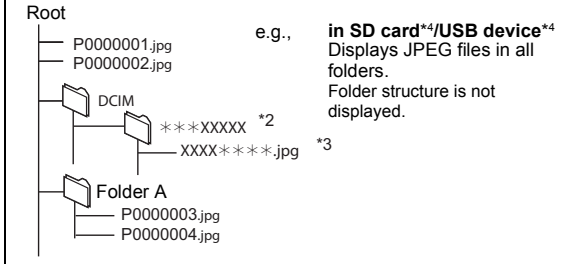
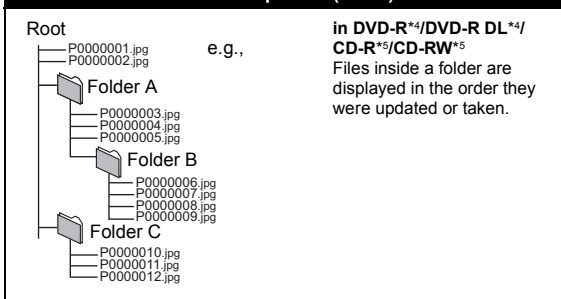

Structure of MP3 folders

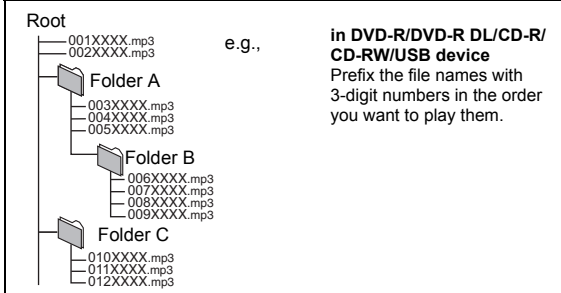

Structure of DivX folders

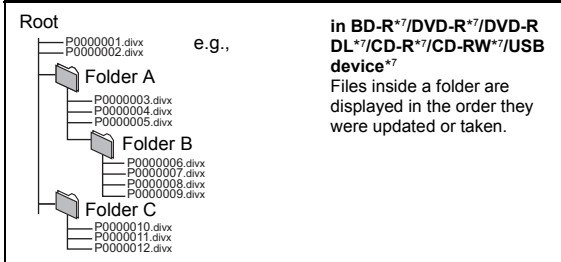

*4 The total combined maximum number of recognizable picture contents and folders: 3000 picture contents and 300 folders.
*5 The total combined maximum number of recognizable picture contents and folders: 999 picture contents and 99 folders.
*6 The total combined maximum number of recognizable picture contents and folders: 9999 picture contents and 300 folders.
*7 The total combined maximum number of recognizable file contents and folders: 200 file contents and 300 folders.

Supplemental information

Display languages list

Display Language	Display Language	Display Language
ENG English	JPN Japanese	ARA Arabic
FRA French	CHI Chinese	HIN Hindi
DEU German	KOR Korean	PER Persian
ITA Italian	MAL Malay	IND Indonesian
ESP Spanish	VIE Vietnamese	MRI Maori
NLD Dutch	THA Thai	BUL Bulgarian
SVE Swedish	POL Polish	RUM Romanian
NOR Norwegian	CES Czech	GRE Greek
DAN Danish	SLK Slovak	TUR Turkish
POR Portuguese	HUN Hungarian	* Others
RUS Russian	FIN Finnish	

Video attribute



Display	Meaning
MPEG-2/MPEG-4 AVC/VC-1	Video recording method
480/576/720/1080	Video Format
24p/50i/60i/50p/60p	Video Frame rate
YCbCr4:2:2/YCbCr4:4:4/RGB	Colour Space
bps (bit per second)	Transfer rate of bit

Audio attribute

Display	Meaning
PCM/ <input type="checkbox"/> Digital/ <input type="checkbox"/> Digital+/ <input type="checkbox"/> TrueHD/DTS/DTS 96/DTS-HD HI RES/ DTS-HD MSTR/MPEG	Signal type
ch (channel)	Number of channels
k (kHz)	Sampling frequency
b (bit)	Number of bits
bps (bit per second)	Transfer rate of bit

Language code list

Language Code	Language Code	Language Code
Abkhazian: 6566	Gujarati: 7185	Rhaeto-Romance: 8277
Afar: 6565	Hausa: 7265	Romanian: 8279
Afrikaans: 6570	Hebrew: 7387	Russian: 8285
Albanian: 8381	Hindi: 7273	Samoan: 8377
Amharic: 6577	Hungarian: 7285	Sanskrit: 8365
Arabic: 6582	Icelandic: 7383	Scots Gaelic: 7168
Armenian: 7289	Indonesian: 7378	Serbian: 8382
Assamese: 6583	Interlingua: 7365	Serbo-Croatian: 8372
Aymara: 6589	Irish: 7165	Shona: 8378
Azerbaijani: 6590	Italian: 7384	Sindhi: 8368
Bashkir: 6665	Japanese: 7465	Singhalese: 8373
Basque: 6985	Javanese: 7487	Slovak: 8375
Bengali; Bangla: 6678	Kannada: 7578	Slovenian: 8376
Bhutanian: 6890	Kashmiri: 7583	Somali: 8379
Bihari: 6672	Kazakh: 7575	Spanish: 6983
Breton: 6682	Kirghiz: 7589	Sundanese: 8385
Bulgarian: 6671	Korean: 7579	Swahili: 8387
Burmese: 7789	Kurdish: 7585	Swedish: 8386
Byelorussian: 6669	Laotian: 7679	Tagalog: 8476
Cambodian: 7577	Latin: 7665	Tajik: 8471
Catalan: 6765	Latvian, Lettish: 7686	Tamil: 8465
Chinese: 9072	Lingala: 7678	Tatar: 8484
Corsican: 6779	Lithuanian: 7684	Telugu: 8469
Croatian: 7282	Macedonian: 7775	Thai: 8472
Czech: 6783	Malagasy: 7771	Tibetan: 6679
Danish: 6865	Malay: 7783	Tigrinya: 8473
Dutch: 7876	Malayalam: 7776	Tonga: 8479
English: 6978	Maltese: 7784	Turkish: 8482
Esperanto: 6979	Maori: 7773	Turkmen: 8475
Estonian: 6984	Marathi: 7782	Twi: 8487
Faroese: 7079	Moldavian: 7779	Ukrainian: 8575
Fiji: 7074	Mongolian: 7778	Urdu: 8582
Finnish: 7073	Nauru: 7865	Uzbek: 8590
French: 7082	Nepali: 7869	Vietnamese: 8673
Frisian: 7089	Norwegian: 7879	Volapük: 8679
Galician: 7176	Oriya: 7982	Welsh: 6789
Georgian: 7565	Pashto, Pushto: 8083	Wolof: 8779
German: 6869	Persian: 7065	Xhosa: 8872
Greek: 6976	Polish: 8076	Yiddish: 7473
Greenlandic: 7576	Portuguese: 8084	Yoruba: 8979
Guarani: 7178	Punjabi: 8065	Zulu: 9085
	Quechua: 8185	

Java and all Java-based trademarks and logos are trademarks or registered trademarks of Sun Microsystems, Inc. in the United States and other countries.
Manufactured under license from Dolby Laboratories. Dolby, Pro Logic, and the double-D symbol are trademarks of Dolby Laboratories.
Manufactured under license under U.S. Patent #'s: 5,451,942; 5,956,674; 5,974,380; 5,978,762; 6,226,616; 6,487,535; 7,392,195; 7,272,567; 7,333,929; 7,212,872 & other U.S. and worldwide patents issued & pending. DTS and the Symbol are registered trademarks, & DTS-HD, DTS-HD Master Audio Essential and the DTS logos are trademarks of DTS, Inc. Product includes software. © DTS, Inc. All Rights Reserved.
This product incorporates copyright protection technology that is protected by U.S. patents and other intellectual property rights. Use of this copyright protection technology must be authorized by Macrovision, and is intended for home and other limited viewing uses only unless otherwise authorized by Macrovision. Reverse engineering or disassembly is prohibited.
HDMI, the HDMI Logo, and High-Definition Multimedia Interface are trademarks or registered trademarks of HDMI Licensing LLC in the United States and other countries.
This product is licensed under the AVC patent portfolio license and VC-1 patent portfolio license for the personal and non-commercial use of a consumer to (i) encode video in compliance with the AVC Standard and VC-1 Standard ("AVC/VC-1 Video") and/or (ii) decode AVC/VC-1 Video that was encoded by a consumer engaged in a personal and non-commercial activity and/or was obtained from a video provider licensed to provide AVC/VC-1 Video. No license is granted or shall be implied for any other use. Additional information may be obtained from MPEG LA, LLC. See http://www.mpegla.com .
HDAVI Control™ is a trademark of Panasonic Corporation.
x.v.Colour™ is a trademark.
VIERA CAST is a trademark of Panasonic Corporation.
"AVCHD" and the "AVCHD" logo are trademarks of Panasonic Corporation and Sony Corporation.
SDXC Logo is a trademark of SD-3C, LLC.
"Blu-ray Disc" is a trademark.
DivX® is a registered trademark of DivX, Inc., and is used under license.
"BD-Live" logo is a trademark of Blu-ray Disc Association.
"BONUSVIEW" is a trademark of Blu-ray Disc Association.
YouTube and Picasa are trademarks of Google, Inc.
<p>"Made for iPod" means that an electronic accessory has been designed to connect specifically to iPod and has been certified by the developer to meet Apple performance standards.</p> 
<p>"Works with iPhone" means that an electronic accessory has been designed to connect specifically to iPhone and has been certified by the developer to meet Apple performance standards. Apple is not responsible for the operation of this device or its compliance with safety and regulatory standards. iPod is a trademark of Apple Inc., registered in the U.S. and other countries. iPhone is a trademark of Apple Inc.</p> 
DLNA®, the DLNA Logo and DLNA CERTIFIED™ are trademarks, service marks, or certification marks of the Digital Living Network Alliance.
Windows is a registered trademark of Microsoft Corporation in the United States and other countries.

<p>This product incorporates the following software:</p> <ol style="list-style-type: none"> (1) the software developed independently by or for Panasonic Corporation, (2) the software owned by third party and licensed to Panasonic Corporation, (3) the software licensed under the GNU General Public License, Version 2 (GPL v2), (4) the software licensed under the GNU LESSER General Public License, Version 2.1 (LGPL v2.1) and/or, (5) open sourced software other than the software licensed under the GPL v2 and/or LGPL v2.1 <p>For the software categorized as (3) and (4), please refer to the terms and conditions of GPL v2 and LGPL v2.1, as the case may be at http://www.gnu.org/licenses/old-licenses/gpl-2.0.html and http://www.gnu.org/licenses/old-licenses/lgpl-2.1.html. In addition, the software categorized as (3) and (4) are copyrighted by several individuals. Please refer to the copyright notice of those individuals at http://www.am-linux.jp/dl/JPRCBW98</p> <p>The GPL/LGPL software is distributed in the hope that it will be useful, but WITHOUT ANY WARRANTY, without even the implied warranty of MERCHANTABILITY or FITNESS FOR A PARTICULAR PURPOSE.</p> <p>At least three (3) years from delivery of products, Panasonic will give to any third party who contacts us at the contact information provided below, for a charge no more than our cost of physically performing source code distribution, a complete machine-readable copy of the corresponding source code covered under GPL v2/LGPL v2.1.</p> <p>Contact Information cdrequest@am-linux.jp</p> <p>Source code is also freely available to you and any other member of the public via our website below. http://www.am-linux.jp/dl/JPRCBW98</p>

Glossary

AVCHD

AVCHD is a new format (standard) for high definition video cameras that can be used to record and play high-resolution HD images.

BD-J

Some BD-Video discs contain Java applications, and these applications are called BD-J. You can enjoy various interactive features in addition to playing normal video.

Bitstream

This is the digital form of multi-channel audio data (e.g., 5.1 channel) before it is decoded into its various channels.

Deep Colour

This unit incorporates HDMI (V.1.4, Content Type) technology that can reproduce greater colour gradation (4096 steps) when connected to a compatible TV.

You can enjoy exceptionally rich, natural-looking colours, with smooth, detailed gradation and minimal colour banding. [A lower colour gradation (256 steps), without Deep Colour, will be reproduced if connected to a TV which does not support Deep Colour.

The unit will automatically set appropriate output to suit the connected TV.]

DLNA (Digital Living Network Alliance)

DLNA is a standard that makes DLNA Certified digital electronics easier and more convenient to use on a home network.

Dolby Digital

This is a method of coding digital signals developed by Dolby Laboratories. Apart from stereo (2-channel) audio, these signals can also be multi-channel audio.

Dolby Digital Plus

Multi-channel audio and higher audio quality is made possible using Dolby Digital Plus. BD-Video supports up to 7.1 channel output.

Dolby Pro Logic II

Dolby Pro Logic II enables you to play stereo sources on 5.1 channel.

Dolby TrueHD

Dolby TrueHD is a very high quality audio format that reproduces the studio master audio. BD-Video supports up to 7.1 channel output.

Down-mixing

This is the process of remixing the multi-channel audio found on some discs into fewer channels.

DTS (Digital Theater Systems)

This surround system is used in many movie theatres. There is good separation between the channels, so realistic sound effects are possible.

DTS-HD

DTS-HD is a high-quality, sophisticated audio format used in movie theatres. Previous DTS Digital Surround-compatible equipment can play DTS-HD as DTS Digital Surround audio. BD-Video supports up to 7.1 channel output.

DTS-HD High Resolution Audio

This is a signal format achieved by improving the previous DTS, DTS-ES and DTS 96/24 formats. It is compatible with sampling frequency 96 kHz/48 kHz. BD-Video supports up to 7.1 channel output.

DTS-HD Master Audio | Essential

This is a lossless audio format and compatible with 96 kHz/7.1 ch and 192 kHz/2 ch or less. In addition, faithful reproduction of the master audio is enabled using lossless audio encoding technology. BD-Video supports up to 7.1 channel output.

Dynamic range

Dynamic range is the difference between the lowest level of sound that can be heard above the noise of the equipment and the highest level of sound before distortion occurs.

Dynamic range compression means reducing the gap between the loudest and softest sounds. This means you can listen at low volumes but still hear dialogue clearly.

HDMI (High-Definition Multimedia Interface)

HDMI is a digital interface for consumer electronic products. Unlike conventional connections, it transmits uncompressed digital video and audio signals on a single cable.

Local storage

This storage area is used as a destination for sub contents for playing BD-Live on BD-Video.

LPCM (Linear PCM)

These are a kind of PCM format.

These are uncompressed digital signals, similar to those found on CDs.

PCM (Pulse Code Modulation)

This is one format for converting analogue audio into digital audio, enabling you to enjoy digital audio with no hassle.

P4HD (Pixel Precision Progressive Processing for HD)

This is a processor which makes use of an exclusive Panasonic algorithm. Various processing is supported, including a high-level conversion of the TV scanning format from interlace to progressive and a high-level conversion of standard resolution (480i or 576i) video signal to a 1080 High Definition video signal.

Consequently, this unit is able to provide video of optimal resolution to the connected TV.

x.v.Colour™

x.v.Colour™ is a name for devices that are compatible with the xVCC format, an international standard for expanded colour in motion pictures, and that follow the rules for signal transmission.

You can enjoy vivid colours of wider colour ranges for a more realistic picture when connected to a TV that supports the x.v.Colour™ with HDMI cable.

24p

This is a progressive image recorded at a rate of 24 frames per second (motion-picture film). Many BD-Video movie contents are recorded in 24 frames/second in accordance with the film materials.

Specifications

GENERAL

Power consumption:	100 W
Power consumption in standby mode	
BT735 BT330	Approx. 0.1 W
BT230	Approx. 0.2 W
Power supply:	AC 220 V to 240 V, 50 Hz

iPod/iPhone Connector:	DC OUT 5 V 500 mA MAX
WIRELESS LAN Connector:	DC OUT 5 V 500 mA (USB 2.0 standard)
Dimensions (W×H×D):	430 mm×54 mm×287 mm
Mass:	Approx. 3.1 kg (Dimensions and Weight do not include speakers)
Operating temperature range:	0 °C to 40 °C
Operating humidity range:	35 % to 80 % RH (no condensation)

AMPLIFIER SECTION

RMS TTL POWER OUTPUT:	1000 W
1 kHz, 10 % total harmonic distortion	
FRONT:	125 W per ch (3 Ω)
CENTRE:	250 W per ch (6 Ω)
SURROUND:	125 W per ch (3 Ω)
100 Hz, 10 % total harmonic distortion	
SUBWOOFER:	250 W per ch (6 Ω)
DIN TTL POWER OUTPUT:	590 W
1 kHz, 1.0 % total harmonic distortion	
FRONT:	90 W per ch (3 Ω)
CENTRE:	115 W per ch (6 Ω)
SURROUND:	90 W per ch (3 Ω)
100 Hz, 1.0 % total harmonic distortion	
SUBWOOFER:	115 W per ch (6 Ω)

FM TUNER SECTION

Preset memory:	30 stations
Frequency range:	87.50 MHz to 108.00 MHz (50 kHz step)
Antenna terminals:	75 Ω (unbalanced)

SPEAKER SECTION

FRONT SPEAKERS

BT735 SB-HF730	
Type:	2 WAY 3 SPEAKER Bass-ref.
Woofers:	3.5 cm × 10 cm CONE TYPE × 2
Tweeter:	2.5 cm SEMI-DOME TYPE
Impedance:	3 Ω
Output sound pressure:	78 dB/W (1 m)
Frequency range:	100 Hz to 30 kHz (−16 dB), 130 Hz to 25 kHz (−10 dB)
Dimensions (W×H×D):	255 mm×1023 mm×255 mm
Mass:	Approx. 2.3 kg

BT330 SB-HF330	
Type:	1 WAY 1 SPEAKER Bass-ref.
Full range:	6.5 cm CONE TYPE
Impedance:	3 Ω
Output sound pressure:	78 dB/W (1 m)
Frequency range:	85 Hz to 25 kHz (−16 dB), 95 Hz to 22 kHz (−10 dB)
Dimensions (W×H×D):	100 mm×530 mm×78 mm
Mass:	Approx. 0.92 kg

Full assembly with stand base

Dimensions (W×H×D)	
Max:	255 mm×1020 mm×255 mm
Min:	255 mm×550 mm×255 mm
Mass:	Approx. 2.3 kg

BT230 SB-HF230	
Type:	1 WAY 1 SPEAKER Bass-ref.
Full range:	6.5 cm CONE TYPE
Impedance:	3 Ω
Output sound pressure:	78 dB/W (1 m)
Frequency range:	105 Hz to 25 kHz (−16 dB), 130 Hz to 22 kHz (−10 dB)
Dimensions (W×H×D):	80 mm×118.5 mm×68 mm
Mass:	Approx. 0.4 kg

CENTRE SPEAKER

BT735 SB-HC730

Type:	2 WAY 3 SPEAKER Bass-ref.
Woofers:	3.5 cm × 10 cm CONE TYPE × 2
Tweeter:	2.5 cm SEMI-DOME TYPE
Impedance:	6 Ω
Output sound pressure:	78 dB/W (1 m)
Frequency range:	100 Hz to 30 kHz (−16 dB), 130 Hz to 25 kHz (−10 dB)
Dimensions (W×H×D):	424 mm×59 mm×76 mm
Mass:	Approx. 1.06 kg

BT330 **BT230** SB-HC230

Type:	1 WAY 1 SPEAKER Bass-ref.
Full range:	6.5 cm CONE TYPE
Impedance:	6 Ω
Output sound pressure:	79 dB/W (1 m)
Frequency range:	90 Hz to 25 kHz (−16 dB), 115 Hz to 22 kHz (−10 dB)
Dimensions (W×H×D):	145 mm×85 mm×71.5 mm
Mass:	Approx. 0.6 kg

SURROUND SPEAKERS

BT735 SB-HS735

Type:	2 WAY 3 SPEAKER Bass-ref.
Woofers:	3.5 cm × 10 cm CONE TYPE × 2
Tweeter:	2.5 cm SEMI-DOME TYPE
Impedance:	3 Ω
Output sound pressure:	78 dB/W (1 m)
Frequency range:	100 Hz to 30 kHz (−16 dB), 130 Hz to 25 kHz (−10 dB)
Dimensions (W×H×D):	255 mm×1023 mm×255 mm
Mass:	Approx. 2.3 kg

BT330 **BT230** SB-HS230

Type:	1 WAY 1 SPEAKER Bass-ref.
Full range:	6.5 cm CONE TYPE
Impedance:	3 Ω
Output sound pressure:	78 dB/W (1 m)
Frequency range:	105 Hz to 25 kHz (−16 dB), 130 Hz to 22 kHz (−10 dB)
Dimensions (W×H×D):	80 mm×118.5 mm×68 mm
Mass:	Approx. 0.4 kg

SUBWOOFER

BT735 **BT330** SB-HW330

Type:	1 WAY 1 SPEAKER (Kelton type)
Woofers:	16 cm CONE TYPE
Passive radiator:	25 cm
Impedance:	6 Ω
Output sound pressure:	78 dB/W (1 m)
Frequency range:	35 Hz to 180 Hz (−16 dB), 40 Hz to 160 Hz (−10 dB)
Dimensions (W×H×D):	180.5 mm×322 mm×351 mm
Mass:	Approx. 4.6 kg

BT230 SB-HW480

Type:	1 WAY 1 SPEAKER Bass-ref.
Woofers:	16 cm CONE TYPE
Impedance:	6 Ω
Output sound pressure:	78 dB/W (1 m)
Frequency range:	40 Hz to 220 Hz (−16 dB), 45 Hz to 180 Hz (−10 dB)
Dimensions (W×H×D):	145 mm×289.5 mm×258 mm
Mass:	Approx. 2.8 kg

VIDEO SECTION

Signal system:	PAL625/50, PAL525/60, NTSC
Video output	
Output level:	1.0 Vp-p (75 Ω)
Output connector:	Pin jack (1 system)
HDMI AV output	
Output format:	480p (525p)/1080i (1125i)/ 720p (750p)/1080p (1125p)
Output connector:	Type A (19 pin) HDMI (V.1.4, Content Type) This unit supports "HDAVI Control 5" function.

LASER Specification

Class 1 LASER Product

Wave length:	790 nm (CDs)/655 nm (DVDs)/ 405 nm (BDs)
Laser power:	No hazardous radiation is emitted with the safety protection

TERMINAL SECTION

USB:	
(Front)	USB 2.0 High Speed
USB port power:	Max 500 mA
Bit rate:	Up to 4 Mbps (DivX)
(Rear)	USB 2.0 (Use for Wireless LAN Adaptor only)
Ethernet:	10BASE-T/100BASE-TX 1 system
SD card slot:	Connector: 1 system

BT735 **BT330** Calibration Mic

Sensitivity:	100 mV, 4.7 kΩ
Terminal:	Mono, 3.5 mm

Audio Input	
AUX:	× 1

Digital Audio Input	
Optical:	× 2
Sampling frequency:	32 kHz, 44.1 kHz, 48 kHz
Audio Format:	PCM, Dolby Digital

Specifications are subject to change without notice.

Index

A		H		R	
AC mains lead connection	18	HDMI	16, 49	Radio	29
Angle	34	High Clarity Sound	35, 38	Random play	35
Audio		I		Re-master	35
Attribute	47	iPod/iPhone	32	Remote control	
Changing audio during play	25	IP address	40	Remote control code	22
Channel	34	J		Using the remote control	7
Language	37	JPEG	46	Repeat play	35
AVCHD	46, 49	L		Resume play function	25
B		LAN	18	S	
BD-J	49	Language		SD card	11, 26
BD-Live	26	Audio	37	Search	25
BD-Video Ratings	37	Code list	47	Setup menu	37
BONUSVIEW	26	Menu	38	Skip	25
C		On-Screen	38	Sleep timer	8
Chapter	26	Soundtrack	34	Slideshow	28
Cleaning		Subtitle	34, 38	Slow-motion	25
Disc	7	Local storage	49	Soundtrack	34
Lens	7	LPCM	49	Status Message	25
Main unit	7	M		Still picture	28
Connection		Menu		Subtitle	34
Antenna	15	Playback	34	Surround sound	24
AUX	16	Pop-up	25	V	
DVD recorder	17	Setup	37	VIERA CAST	34
HDMI	17	MPEG2	46	VIERA Link "HDAVI Control™"	31
iPod/iPhone	32	MP3	46	W	
OPTICAL IN	16, 17	Mute the sound	8	Whisper-mode Surround	24
Set Top Box	17	O		X	
Speaker	15	On-Screen		x.v.Colour™	49
TV	16	Language	38		
USB	22	Status Message	25		
Video cassette recorder	17	P			
Wireless LAN	18	Picture-in-picture	26		
Wireless system	14	Playback			
D		AVCHD	25		
Deep Colour	49	DivX	27		
Default Settings	40	JPEG	28		
Dialog Enhancer	35	MPEG2	25		
Direct Navigator	25	MP3	27		
Disc and card handling	7	Playback Information Window	35		
DivX	46	Playlists	23		
DLNA	36	Pop-up menu	25		
Dolby Digital	38, 49	Product Disposal	7		
Dolby Digital Plus	38, 49	Progressive	35		
Dolby Pro Logic II	24, 49	Properties			
Dolby TrueHD	38, 49	Title	26		
DTS	38, 49	Still picture	28		
DTS-HD	38, 49	Proxy Server	40		
F		P4HD	49		
Finalize	11	Q			
Firmware update	21	Quick Start	40		
Formatting SD cards	26				
Frame-by-frame	25				



Panasonic Corporation
Web Site: <http://panasonic.net>

Pursuant to at the directive 2004/108/EC, article 9(2)
Panasonic Testing Centre
Panasonic Marketing Europe GmbH
Winsbergring 15, 22525 Hamburg, Germany
© Panasonic Corporation 2010

En

VQT2Q52
F0210SB0